

Serial no.
02-62276

Heathkit® Manual

for the

ANTENNA NOISE BRIDGE

Model HD-1422

595-3467-01

HEATH COMPANY
BENTON HARBOR, MICHIGAN 49022

Copyright © 1985
Heath Company
All Rights Reserved
Printed in the United States of America

This manual is provided FREE OF CHARGE from the “BoatAnchor Manual Archive” as a service to the Boatanchor community.

It was uploaded by someone who wanted to help you repair and maintain your equipment.

If you paid anyone other than BAMA for this manual, you paid someone who is making a profit from the free labor of others without asking their permission.

You may pass on copies of this manual to anyone who needs it. But do it without charge.

Thousands of files are available without charge from BAMA. Visit us at <http://bama.sbc.edu>

Table of Contents

Introduction	2	Tuned Circuit and Component Measurements	22
Assembly Notes	3	Transmission Line Adjustments	23
Parts List	7	Antenna Tuner Adjustments	23
Step-by-Step Assembly	10	In Case of Difficulty	25
Circuit Board	10	Visual Checks	25
Chassis	15	Troubleshooting Chart	26
Tests and Adjustments	17	Specifications	27
Resistance Tests	17	Circuit Description	28
Voltage Tests	17	Semiconductor Identification	29
Adjustments	18	Circuit Board X-Ray View	30
Final Assembly	19	Schematic (Illustration Booklet, Page 10)	
Operation	19	Warranty	Inside front cover
Control Functions	19	Customer Service	Inside rear cover
Measurements	20		
Antenna Measurements	20		

INTRODUCTION

The Heathkit Model HD-1422 Antenna Noise Bridge is a useful tool for the shortwave listener or amateur radio operator who demands maximum performance from his antenna system. An SWR bridge tells you how well an antenna is matched to your station transmitter; the Antenna Noise Bridge tells you what is causing any mismatch.

A tone-modulated, broadband noise signal is generated in the Antenna Noise Bridge and coupled to an impedance bridge. Then, using your station receiver as an indicator, the impedance bridge measures the resistive and reactive components of your antennas. This allows you to trim each antenna to a favorite operating frequency for the most effective transmission and reception of signals. In addition, you can use the Noise Bridge to preset an antenna tuner for faster tune-up, to tune a quarter-wave trans-

mission line, and to measure the value of unknown capacitors and inductors.

An LED on the front panel lights when the Noise Bridge is turned on. And the front panel controls give you a direct readout of the resistive and reactive characteristics of the antenna being tested. The rear panel includes an external power jack, and coaxial connectors (SO239) for the receiver and unknown antenna connections.

The compact design of the Antenna Noise Bridge allows you to place it where the antenna is. It operates from a single 9-volt transistor battery (not supplied) for portable use, or from the (optional) PS-2350 AC power supply for in-the-shack use. The versatility of this unit will make it a welcome addition to your ham shack or test bench.

ASSEMBLY NOTES

TOOLS

You will need these tools to assemble your kit.

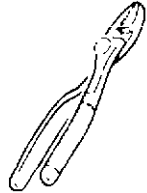

PLIERS

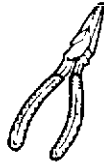

LONG-NOSE
PLIERS

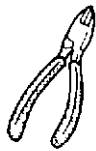

DIAGONAL
CUTTERS

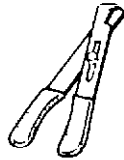

WIRE
STRIPPERS

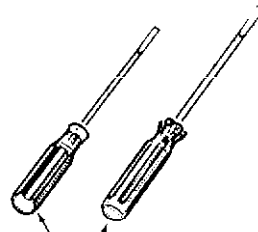

1/8" & 1/4"-BLADE
SCREWDRIVERS

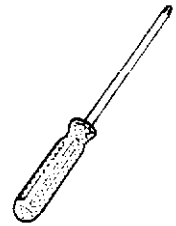

PHILLIPS
SCREWDRIVER

OTHER HELPFUL TOOLS



NUT STARTER
(May Be Supplied
With Kit)

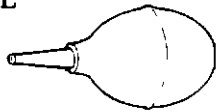

DESOLDERING
BULB*



DESOLDERING
BRAID*

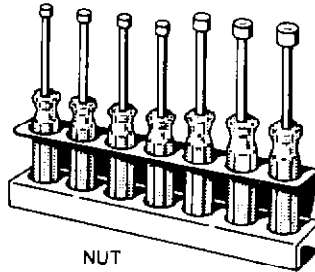

NUT
DRIVERS

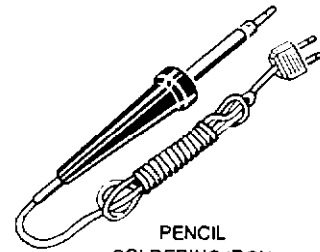

PENCIL
SOLDERING IRON
(22 to 25 WATTS)

*To Remove Solder From Circuit Connections

ASSEMBLY

1. Follow the instructions carefully. Read the entire step before you perform each operation.
2. Refer to the separate "Illustration Booklet" for the Pictorials and Details. Keep the "Illustration Booklet" with the Assembly Manual. The illustrations in it are arranged in the proper sequence, as called for in the steps.
3. Pictorials show the overall operation for a group of assembly steps; Details generally illustrate a single step. When you are directed to refer to a certain Pictorial "for the following steps," continue using that Pictorial until you are referred to another Pictorial for another group of steps.
4. Position all parts as shown in the Pictorials.
5. Solder instructions are generally given only at the end of a series of similar steps. You may solder more often if you desire.

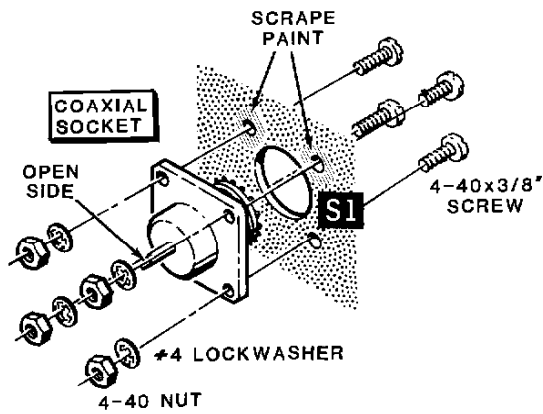

DETAIL 2-1A

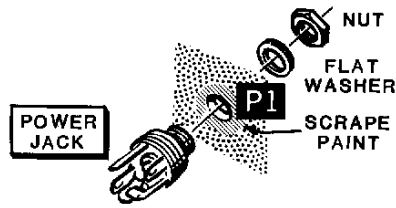

DETAIL 2-1B

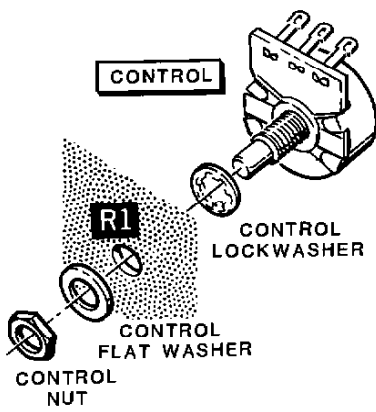

DETAIL 2-1C

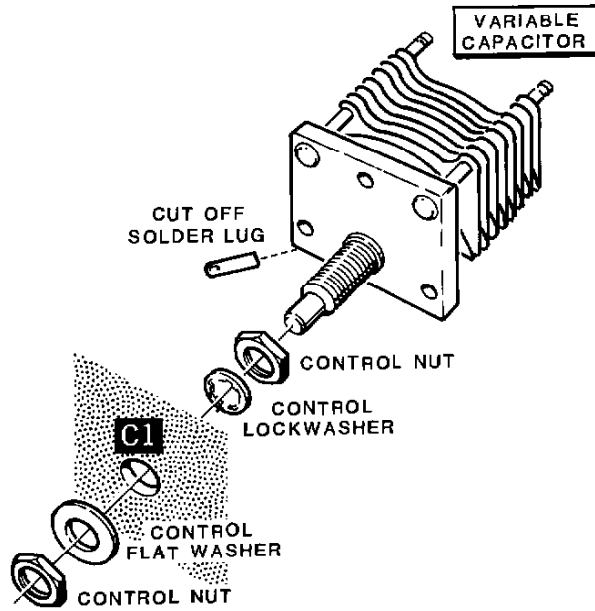

DETAIL 2-1D

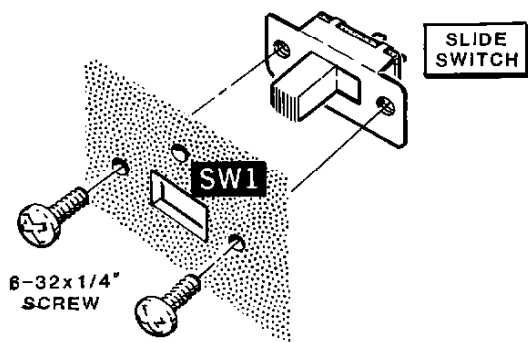

DETAIL 2-1E

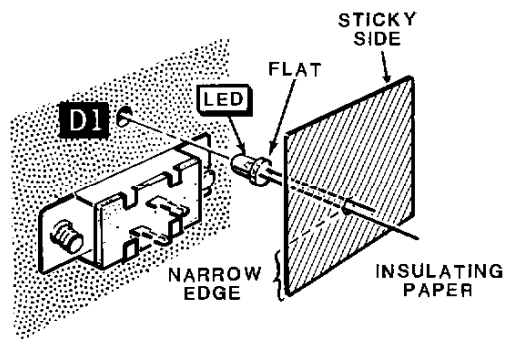

DETAIL 2-1F

6. Each circuit part in an electronic kit has its own component number (R2, C4, etc.). Use these numbers when you want to identify the same part in the various sections of the Manual. These numbers, which are especially useful if a part has to be replaced, appear:
- In the Parts List,
 - At the beginning of each step where a component is installed,
 - In some illustrations,
 - In Troubleshooting Charts,
 - In the Schematic,
 - In the sections at the rear of the Manual.
7. When you are instructed to cut something to a particular length, use the scales (rulers) provided at the bottom of the Manual pages.

SAFETY WARNING: Avoid eye injury when you cut off excessive lead lengths. Hold the leads so they cannot fly toward your eyes.

SOLDERING

Soldering is one of the most important operations you will perform while assembling your kit. A good solder connection will form an electrical connection between two parts, such as a component lead and a circuit board foil. A bad solder connection could prevent an otherwise well-assembled kit from operating properly.

It is easy to make a good solder connection if you follow a few simple rules:

1. Use the right type of soldering iron. A 22 to 25-watt pencil soldering iron with a 1/8" or 3/16" chisel or pyramid tip works best.
2. *Keep the soldering iron tip clean. Wipe it often on a wet sponge or cloth; then apply solder to the tip to give the entire tip a wet look. This process is called tinning, and it will protect the tip and enable you to make good connections. When solder tends to "ball" or does not stick to the tip, the tip needs to be cleaned and retinned.*

NOTE: Always use rosin core, radio-type solder (60:40 tin-lead content) for all of the soldering in this kit. This is the type we have supplied with the parts. The Warranty will be void and we will not service any kit in which acid core solder or paste has been used.

PARTS

Resistors are identified in Parts Lists and steps by their resistance value in Ω (ohms), $k\Omega$ (kilohms), or $M\Omega$ (megohms). They are usually identified by a color code of four or five color bands, where each color represents a number. These colors (except for the last band, which indicates a resistor's "tolerance") will be given in the steps in their proper order. Therefore, the following color code is given for information only. NOTE: Occasionally, a "precision" or "power" resistor may have the value stamped on it.

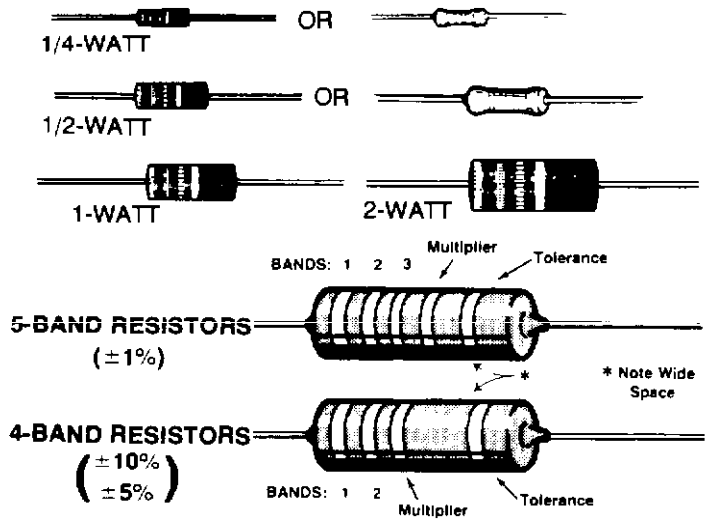

Band 1 1st Digit		Band 2 2nd Digit		Band 3 (if used) 3rd Digit		Multiplier		Resistance Tolerance	
Color	Digit	Color	Digit	Color	Digit	Color	Multiplier	Color	Tolerance
Black	0	Black	0	Black	0	Black	1	Silver	$\pm 10\%$
Brown	1	Brown	1	Brown	1	Brown	10	Gold	$- 5\%$
Red	2	Red	2	Red	2	Red	100	Red	$\pm 2\%$
Orange	3	Orange	3	Orange	3	Orange	1,000	Brown	$\pm 1\%$
Yellow	4	Yellow	4	Yellow	4	Yellow	10,000	Green	$\pm 5\%$
Green	5	Green	5	Green	5	Green	100,000	Blue	$\pm 25\%$
Blue	6	Blue	6	Blue	6	Blue	1,000,000	Violet	$\pm .1\%$
Violet	7	Violet	7	Violet	7	Silver	0.01	Gray	$\pm .05\%$
Gray	8	Gray	8	Gray	8	Gold	0.1		
White	9	White	9	White	9				

Capacitors will be called out by their capacitance value in μF (microfarads) or pF (picofarads) and type: ceramic, Mylar*, electrolytic, etc. Some capacitors may have their value printed in the following manner:

EXAMPLES:

$$151K = 15 \times 10 = 150 \text{ pF}$$

$$759 = 75 \times 0.1 = 7.5 \text{ pF}$$

NOTE: The letter "R" may be used at times to signify a decimal point: as in: 2R2 = 2.2 (pF or μF).

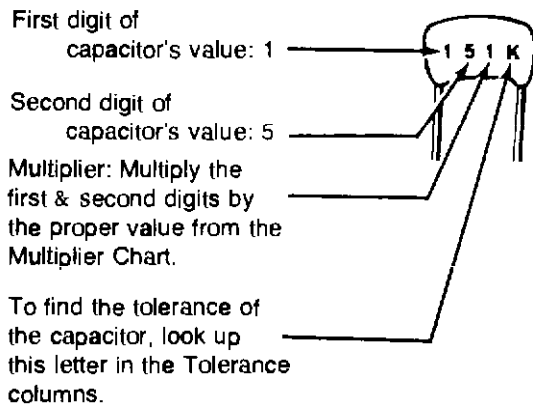

MULTIPLIER		TOLERANCE OF CAPACITOR		
FOR THE NUMBER:	MULTIPLY BY	10 pF OR LESS	LETTER	OVER 10 pF
0	1	$\pm 0.1 \text{ pF}$	B	
1	10	$+0.25 \text{ pF}$	C	
2	100	$\pm 0.5 \text{ pF}$	D	
3	1000	$\pm 1.0 \text{ pF}$	F	$\pm 1\%$
4	10,000	-2.0 pF	G	$\pm 2\%$
5	100,000		H	$\pm 3\%$
			J	$\pm 5\%$
8	0.01		K	$\pm 10\%$
9	0.1		M	$\pm 20\%$

*DuPont Registered Trademark.

SPECIAL ASSEMBLY NOTES

NOTE: The following suggestions will not necessarily improve the operation of your kit. They will, however, help you troubleshoot it (if it ever becomes necessary), and help you perform the "Circuit Board Checkout" steps at the end of the assembly sections of this Manual. And you will have a more professionally-built kit when you finish.

1. When you install resistors, always position each resistor so you can read the bands on the resistor in the same direction as you can read the printing on the circuit board (see Figure 1). For resistors that have the value printed on them instead of color bands, install these resistors so the values are facing away from the circuit board and read in the same direction as the printing on the circuit board.

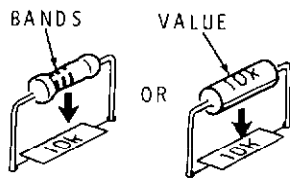

Figure 1

2. When you install ceramic, Mylar, or mica capacitors, always position each capacitor so you can read the value on the capacitor in the same direction as you can read the printing on the circuit board (see Figure 2).

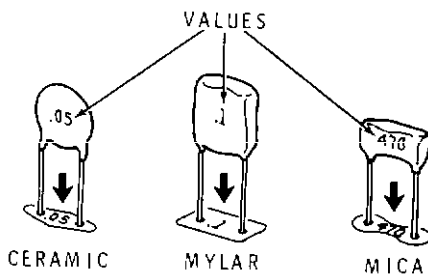

Figure 2

3. When you install electrolytic or other tubular capacitors, always position each capacitor so the value is facing away from the circuit board (see Figure 3). Be sure to observe the correct polarity when you install electrolytic capacitors (as you will be directed in the steps). Other, non-polarized, capacitors should be installed so you can read the values in the same direction as the printing on the circuit board.

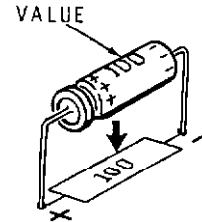

Figure 3

4. Install diodes so the type numbers or part numbers are facing away from the circuit board. Be sure to match the band on one end of each diode with the band mark on the circuit board.

PARTS LIST

Open the Parts Pack and check each part against the following list. The key numbers correspond to the numbers on the Parts Pictorial. Do not remove any parts that are supplied on the tape strip until they are called for in an assembly step. If a part is packed in an individual envelope with a part number on it, identify the part; then place it back into the envelope until a step calls for it. Do not throw away any packing materials until you have accounted for all the parts.

To order a replacement part, always include the PART NUMBER. Use the Parts Order Form furnished with this kit. If a Parts Order Form is not available, refer to "Replacement Parts" inside the rear cover of this Manual. For prices, refer to the separate "Heath Parts Price List."

KEY HEATH	QTY.	DESCRIPTION	CIRCUIT
No. Part No.	_____	_____	Comp. No.

CAPACITORS

A1	20-76	1	68 pF mica	C107
A1	20-102	1	100 pF mica	CTEST
A2	21-176	5	.01 μ F ceramic	C101, C102, C104, C105, C106
A2	21-95	1	.1 μ F ceramic	C103
A3	26-163	1	7-120 pF variable	C1

TRANSISTORS-INTEGRATED CIRCUIT (IC)

NOTE: Transistors and integrated circuits may be marked for identification in any one of the following four ways:

1. Part number.
2. Type number. (For integrated circuits, this refers only to the numbers printed in **bold type**; the letters may be different or missing).
3. Part number and type number.
4. Part number with a type number other than the one listed.

B1	417-293	2	2N5770 transistor	Q101, Q102
B2	442-53	1	NE555 IC	U101

KEY HEATH	QTY.	DESCRIPTION	CIRCUIT
No. Part No.	_____	_____	Comp. No.

HARDWARE

NOTE: The hardware is shown full size so you can place any nut, screw, etc. over the drawing. Also, the hardware may be packed in more than one envelope. Open all of the envelopes (marked HDW) before you check the hardware against the Parts List.

#3 Hardware

C1	250-49	2	3-48 \times 1/4" screw	
C2	252-1	2	3-48 nut	
C3	254-7	2	#3 lockwasher	

#4 Hardware

D1	250-1412	8	4-40 \times 3/8" screw	
D2	252-2	8	4-40 nut	
D3	254-9	7	#4 lockwasher	
D4	259-9	1	#4 solder lug	

BATTERY

We suggest that you purchase one 9-volt transistor battery, NEDA #1604, at this time for use in your kit. Representative manufacturers and their type numbers are:

- Eveready #216 or #1222
- Mallory #M1604
- Mallory #TR-146X (long life)
- Burgess #2V6
- RCA #VS323
- Hellesens #410
- Varta #438

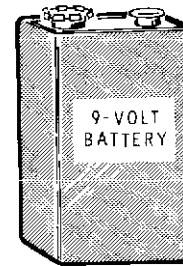

TAPED COMPONENTS

The remaining parts are supplied on a taped strip. It is not necessary to check them against the following list.

<u>HEATH</u> <u>Part No.</u>	<u>QTY.</u>	<u>DESCRIPTION</u>	<u>CIRCUIT</u> <u>Comp. No.</u>	<u>HEATH</u> <u>Part No.</u>	<u>QTY.</u>	<u>DESCRIPTION</u>	<u>CIRCUIT</u> <u>Comp. No.</u>
RESISTORS				DIODES			
NOTE: The following resistors are rated at 1/4-watt and have a tolerance of 5%.				56-6	1	VR6.8	D103
6-103-12	1	10 kΩ (brn-blk-org)	R106	56-56	2	1N4149	D101, D102
6-122-12	1	1200 Ω (brn-red-red)	R104				
6-182-12	1	1800 Ω (brn-gry-red)	R106				
6-223-12	1	22 kΩ (red-red-org)	R107				
6-391-12	1	390 Ω (org-whl-brn)	R101				
6-471-12	1	470 Ω (yel-viol-brn)	R109				
6-510-12	1	51 Ω (grn-brn-blk)	RTEST				
6-661-12	1	680 Ω (blu-gry-brn)	R105				
6-682-12	2	6800 Ω (blu-gry-red)	R102, R103				

STEP-BY-STEP ASSEMBLY

CIRCUIT BOARD

Refer to Pictorial 1-1 as you read the following notes and perform the following steps.

NOTES:

1. Many circuit board drawings, such as the one shown in Pictorial 1-1, are divided into two or more sections. These sections show you which area of the circuit board you are working in for a specific series of steps.
2. Cut the "Taped Component Chart" from the last page in this Manual. Make sure you read the instructions at the top of the chart before you use it. Note that it is divided into numbered sections that correspond to the numbered sections on the circuit board pictorial. The components are listed in the order of assembly.
3. In each series of steps, which corresponds to a circuit board section, you will install parts in a top-to-bottom, left-to-right sequence. Occasionally, you may be directed to install a particular component in an area out of sequence. Each of these components is identified in the step and on the Pictorial with a special callout (R201, C403, or D111, for example).

4. As you perform each step, check it off in the box provided. You may also wish to place a check mark near each component on the Pictorial as you install the part.
5. In general, solder instructions are given only at the end of a series of similar steps; you may solder more often if you wish.

In the following steps, you will be given detailed instructions on how to install and solder the first part on the circuit board. Read and perform each step carefully. Then use the same procedure as you install the remaining parts on the board.

Note that the circuit board has foil patterns on one side and the other side has outlines of components (parts) shown on it. The foil side of the board will be referred to as the "bottom" of the board, and the side with the outlines, the "top" of the board.

- () Position the circuit board on your work area in front of you with the top side up as shown in Pictorial 1-1. NOTE: Always install parts on the top of a circuit board and solder the leads or wires to the bottom circuit board foil pads.

- () Cut the first part, a 390 Ω (org-wht-brn) resistor, from the Taped Component Chart as outlined in the Chart instructions. Bend the resistor leads as shown to fit the hole spacing for R101 on the circuit board.

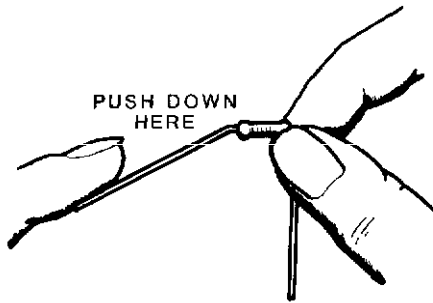

- () R101: Start the leads into the holes at the resistor's location near the top of Section 1 of the circuit board. The end with the color bands may be positioned either way. NOTE: Resistors are identified by the following outline:

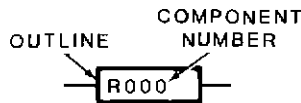

- () Press the resistor down against the top of the circuit board. Then bend the leads outward slightly to hold it in place.



- () Solder the resistor leads to the circuit board as follows:

1. Push the soldering iron tip against both the lead and the circuit board foil. Heat both for two or three seconds.

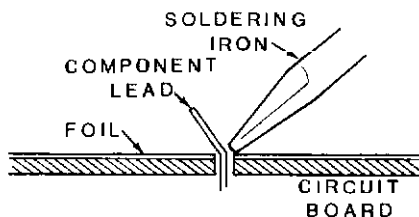

2. Then apply solder to the other side of the connection. IMPORTANT: Let the heated lead and the circuit board foil melt the solder, NOT the soldering iron.

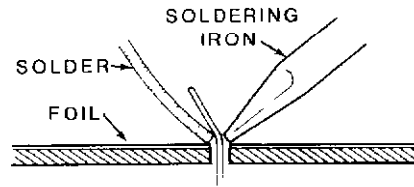

3. As the solder begins to melt, allow it to flow around the connection. Then remove the solder and the iron and let the connection cool.

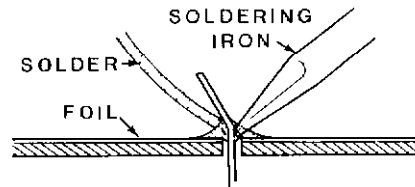

- () Cut off the excess lead lengths close to the connection. WARNING: Clip the leads so the ends will not fly toward your eyes.

- () Check each connection. Compare it to the illustrations in Detail 1-1A. After you have checked the solder connections, proceed with the assembly on this and on the following pages. Use the same soldering technique for each connection.

Start at the top of Section 1 and install the following parts. The sequence of the steps matches the location of the components on the circuit board. NOTE: Make sure you installed R101 in an earlier step.

In order to make the assembly easier, you may wish to cut the parts from a section of the Taped Components Chart and, as you do this, prebend the leads and lay the parts on your work area in the exact order of assembly. Then you can hold the circuit board while you install the parts in sequence without interruption.

Section 1

- (/) R102: 6800 Ω (blu-gry-red) resistor.
- (') R103: 6800 Ω (blu-gry-red) resistor.
- () R107: 22 k Ω (red-red-org) resistor.

NOTE: In some of the following steps, you will install diodes. Always position the banded end of the diode over the band mark on the circuit board. **If you install a diode incorrectly, the circuit will not operate properly.**

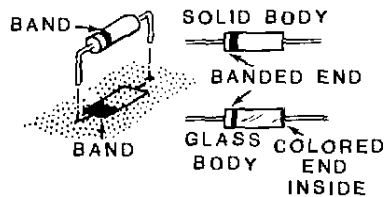
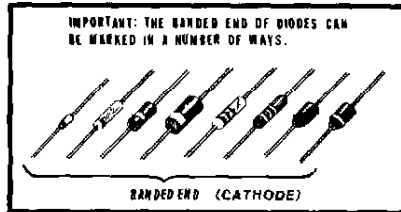

CAUTION: ALWAYS POSITION THE BANDED END OF A DIODE AS SHOWN ON THE CIRCUIT BOARD.

- (\) D101: 1N4149 diode (#56-56).
- (\) D102: 1N4149 diode (#56-56).
- (/) R106: 1800 Ω (brn-gry-red) resistor.

- (/) D103: VR6.8 diode (#56-6).
- (/) Solder the leads to the foil and cut off the excess lead lengths.

Section 2

- (/) R104: 1200 Ω (brn-red-red) resistor.
- (\) R108: 10 k Ω (brn-blk-org) resistor.
- (\) R105: 680 Ω (blu-gry-brn) resistor.
- (\) R109: 470 Ω (yel-viol-brn) resistor.
- (/) Solder the leads to the foil and cut off the excess lead lengths.
- (/) Cut the remaining 51 Ω (grn-brn-blk) resistor from the strip and set it aside until it is called for later.

Refer to Pictorial 1-2 (Illustration Booklet, Page 2) for the following steps.

As you install the IC socket, be very careful that you do not bridge solder between socket pins. Solder that is bridged between two pins that are on the same foil is all right. If you should form a solder bridge, hold the circuit board bottom side down as shown. Then hold your soldering iron tip between the two points where solder is bridged. The solder will flow down the iron. You can also use desoldering braid (not supplied).

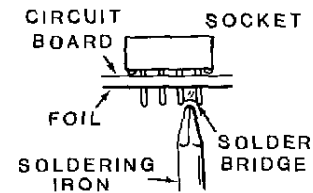

Before you install the IC socket, make sure the pins are straight. If there is any kind of identification mark (notch, dot, arrowhead, etc.) at or near one end of the socket, place this marked end toward the index mark on the circuit board (this index mark should still be visible after you install the socket). Then start the pins into the circuit board holes and solder them to the foil.

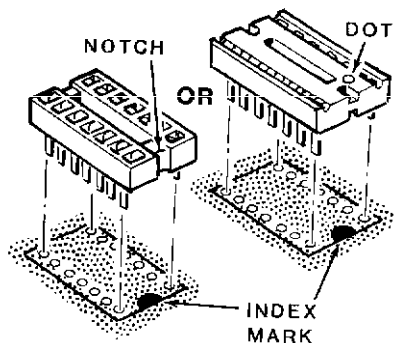

() U101: 8-pin IC socket.

In the following steps, you will install disc-type ceramic capacitors. When you install these capacitors, do not push the insulated portion of the leads into the circuit board holes. This could make it difficult to solder the leads to the foil.

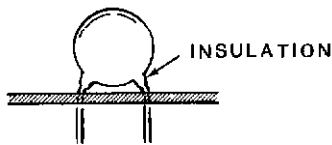

- () C101: .01 μF ceramic capacitor.
- () C107: 68 pF mica capacitor.
- () C105: .01 μF ceramic capacitor.
- () C103: .1 μF ceramic capacitor.
- () C106: .01 μF ceramic capacitor.
- () C104: .01 μF ceramic capacitor.
- () C102: .01 μF ceramic capacitor.
- () Solder the leads to the foil and cut off the excess lead lengths.

Refer to Pictorial 1-3 for the following steps.

Refer to Detail 1-3A to install the IC.

() U101: 555 IC (#442-53).

When you install each of the following transistors, position the flat on the transistor over the outline of the flat on the circuit board. Then insert the leads into the circuit board holes and solder them to the foil. Cut off any excess lead lengths.

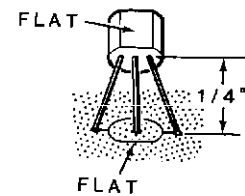

() Q101: 2N5770 (#417-293).

() Q102: 2N5770 (#417-293).

NOTE: When a step calls for hardware, only the screw size is given. For instance, if "3-48 \times 1/4" hardware" is called for, it means you should use a 3-48 \times 1/4" screw, one or more #3 lockwashers, and a 3-48 nut at the indicated mounting hole. The Detail referred to in the step will show the proper number and placement of each hardware item.

- () Refer to Detail 1-3B and mount the battery clip at F and G. Use 3-48 \times 1/4" hardware.
- () Cut a 9" brown, a 9" gray, and a 9" white wire.
- () Twist one end of each of these wires together.
- () Refer to Detail 1-3C and wind a transformer as directed in the following steps.
 1. Pull the twisted ends of the wires through the toroid core until 1" extends from the core.
 2. Loop the wires through the core, pulling them tight against the core, until you have seven turns on it. NOTE: It will be easier to wind the core if you keep the turns flat. However, windings may cross if it is necessary.
 3. Separate the wire ends where you twisted them together.
 4. Shorten the leads of this transformer to 3/8" and remove 1/4" of insulation from each end.

T101: Connect and solder the leads on one side of the prepared transformer to the following circuit board holes:

- () Brown to hole 1.
- () White to hole 2.
- () Gray to hole 3.

Connect and solder the leads on the other side of the transformer as follows:

- () Brown to hole 4.
- () Gray to hole 6.
- () White to hole 5.

NOTE: To prepare a wire, as in the following step, cut the wire to the proper length and remove 1/4" of insulation from each end.

- () Prepare the following wires:

Two 6" red	One 2-1/2" white
One 6" black	Two 2" white

NOTE: In the following steps, you will solder only one end of each wire to the circuit board. You will be instructed to connect the free end of each of these wires later.

Connect and solder one end of each of the prepared wires as follows:

- () One 6" red wire to hole A.
- () The 6" black wire to hole B.
- () The remaining 6" red wire to hole 9V.
- () One 2" white wire to hole D.
- () The other 2" white wire to hole E.
- () The 2-1/2" white wire to hole C.

- () Cut both leads of the battery connector to 4"; then remove 1/4" of insulation from each lead. Tightly twist together the strands at the end of each wire. Then melt a small amount of solder on the wire ends to hold the strands together.

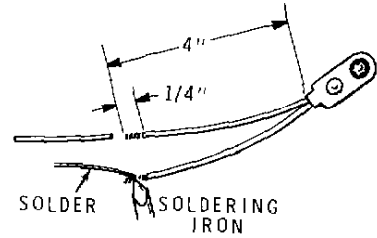

- () Connect and solder the black battery connector lead to hole GND. The red lead will be connected later.

Circuit Board Checkout

Carefully inspect the circuit board for the following most-commonly-made errors:

- () Unsoldered connections.
- () Poor solder connections.
- () Solder bridges between foil patterns.
- () Protruding leads which could touch together or touch the chassis when the circuit board is installed later.

Refer to the illustrations where parts are installed as you make the following checks:

- () Transistors for proper installation.
- () Diodes for the correct type and correct position of the banded ends.
- () IC for proper installation.

Set the circuit board aside temporarily.

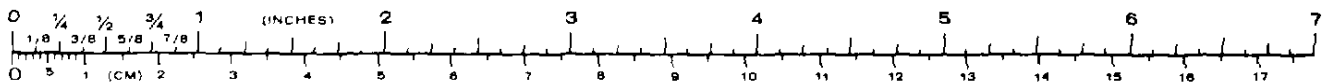

CHASSIS

Refer to Pictorial 2-1 for the following steps.

- () Turn the chassis upside down. Then peel the backing paper from one of the feet. Refer to the inset of the Pictorial and press a foot onto the chassis bottom at the location shown.
- () Similarly, press a foot onto the chassis bottom at each of the remaining corners.
- () Position the chassis as shown in the Pictorial.
- () Scrape any paint from around the indicated chassis holes.
- () S1: Refer to Detail 2-1A and position a coaxial socket at S1 as shown. Be sure the open side of the lug is toward the top of the panel. Then mount the socket using $4-40 \times 3/8$ " hardware.
- () S2: Similarly, mount a coaxial socket at S2. Use $4-40 \times 3/8$ " hardware. Use a #4 solder lug in place of the lockwasher at the position indicated. Position the solder lug as shown.
- () P1: Refer to Detail 2-1B and mount a power jack at P1. Use the hardware furnished with the jack.
- () Mount an $8-32 \times 1/2$ " screw at chassis hole A. Use two #8 lockwashers and an 8-32 nut. Then slide two #8 flat washers onto the screw and secure them with another 8-32 nut. Tighten the second nut only finger tight.
- () Refer to the Pictorial and mount $6-32 \times 1/2$ " screws at K, L, M, and N. Use two 6-32 nuts at each location.
- () R1: Refer to Detail 2-1C and mount a 200Ω control at R1. Use a control lockwasher, a control flat washer, and a control nut.
- () C1: Refer to Detail 2-1D and cut off the solder lug of the variable capacitor. Then install a control nut all the way onto the capacitor bushing and mount the capacitor at C1. Use a control lockwasher, a control flat washer, and another control nut.

- () SW1: Refer to Detail 2-1E and mount the slide switch at SW1, using two $6-32 \times 1/4$ " screws. Position the switch lugs as shown in the Pictorial, with the end lug toward C1.
- () Cut the longer lead of the LED to $5/8$ " and the other lead to $1/2$ ".

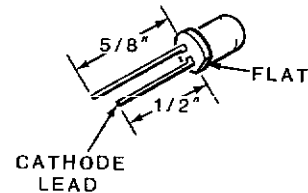

- () D1: Refer to Detail 2-1F and install the LED (#412-633) into chassis hole D1 in the following manner:
 1. Position the flat on the LED (side with the shorter lead) away from capacitor C1.
 2. Carefully peel the backing from the insulating paper. Then slide the insulating paper, narrow edge down, over the leads of the LED, making sure the sticky side of the paper faces the front of the chassis.
 3. Tilt the insulating paper so it rests against the top edge of SW1. Then press it firmly onto the chassis. Be sure the flat on the LED remains toward the side of the chassis and away from C1.

Refer to Pictorial 2-2 for the following steps.

- () Place #6 lockwashers over the screws at K, L, M, and N.
- () Position the circuit board onto the screws and secure it with four 6-32 nuts.

NOTE: In the following steps, (NS) means not to solder because other wires will be connected later. "S-" with a number, such as (S-2), means to solder the connection. The number following the "S-" tells how many wires are in the connection.

Connect the wires from the circuit board as follows:

- () White wire from hole E to S1 (S-1). Position the wire as shown.
- (X) White wire from hole D to S2 (S-1). Position the wire as shown.
- () Red wire from hole 9V to SW1 lug 1 (S-1).
- () White wire from hole C to control R1 lug 1 (S-1).
- () Cut the prepared ends of the red wire coming from hole A and the black wire coming from hole B to 1/8".
- (X) Refer to Detail 2-2A Part A and install spring connectors on the red and black wires.
- (X) Refer to Part B of the Detail and position the 2-pin socket shell so the slots are up as shown. Then position the spring connector on the black wire so the locking tab is up, and push it into hole 1 of the socket shell until it locks into place.
- () Similarly, insert the red lead into hole 2 of the socket shell.
- () Push the socket shell onto the leads of LED D1. Be sure the red wire is on the longer lead (lead closest to C1).
- () Connect the red lead coming from the battery connector to lug 2 of power jack P1 (S-1).

- (X) Prepare a 6" red wire. Connect this wire between power jack P1 lug 3 (S-1) and switch SW1 lug 2 (S-1).
- () Prepare a 1-3/4" white wire. Connect this wire between control R1 lug 2 (S-1) and capacitor C1 lug 1 (S-1).
- () Position the wires coming from D1 and SW1 down along the edge of the circuit board as shown.
- () Rotate the shaft of control R1 fully counter-clockwise.
- (X) Refer to the inset drawing and rotate the shaft of capacitor C1 until the plates are half-meshed.
- () Refer to Detail 2-2B and start a 6-32 x 1/8" setscrew into each knob.
- () Install one knob on the shaft of control R1. Position the knob pointer over the zero (0) mark and tighten the setscrew.
- () Install the remaining knob onto the shaft of capacitor C1. Position the knob pointer over the zero (0) mark and tighten the setscrew.

This completes the assembly of your Heathkit Antenna Noise Bridge. Carefully examine the chassis for unsoldered connections, broken wires, and wiring errors. Shake out any wire clippings, solder splashes, or foreign objects which can be caught in the plates of the variable capacitor. Then proceed to the "Tests and Adjustments."

TESTS AND ADJUSTMENTS

In the first part of this section, you will need a volt-ohmmeter (VOM or VTVM) to make resistance and voltage tests. The voltmeter characteristics are not critical. The second part requires a shortwave (or amateur radio) receiver covering 10 to 15 MHz. The receiver should have a relative signal strength (S) meter; however, an AC voltmeter connected to the receiver speaker can be used in place of a signal meter. The receiver should also be able to receive AM or wide-band, single-sideband (SSB) signals.

Do not connect a battery or power supply to your Antenna Noise Bridge until you are instructed to do so.

RESISTANCE TESTS

Refer to Pictorial 3-1 for the test point locations.

NOTE: The readings in the following steps are the minimum desired. If you measure significantly less, you must determine the reason (such as a solder bridge between foils) and correct it before proceeding. Allow the ohmmeter to reach its highest reading before moving to the next step.

- () Connect the common lead of your ohmmeter to the chassis.
- () Set your ohmmeter to the $R \times 1000$ range.
- () Touch the other ohmmeter lead to SW1 lug 2. The reading should be infinity with the POWER switch OFF.
- () Place POWER switch SW1 to ON. The reading should be 3000Ω (3 k Ω) or higher. Place the POWER switch to OFF.
- () Touch the ohmmeter lead to control R1 lug 2. The reading should be infinity with the POWER switch ON or OFF.
- () Place the POWER switch to OFF.

VOLTAGE TESTS

Your HD-1422 Antenna Noise Bridge can be powered by one 9-volt transistor battery or the optional Model PS-2350 power supply. If you plan to use a battery for power, complete the steps under "With Battery." For operation from the optional power supply, proceed to "With Power Supply."

With Battery

- () Connect the battery connector to the 9-volt battery.
- () Position the battery into the battery clip as shown.
- () Connect the common voltmeter lead to the chassis.
- () Place POWER switch SW1 to ON. LED D1 should light.
- () Touch the voltmeter lead to SW1 lug 2. The reading should be at least +8.5 volts DC.
- () Place the POWER switch to OFF.

Proceed to "Adjustments."

With Power Supply

If you plan to operate your Antenna Noise Bridge from a Power Supply, complete the following steps. NOTE: You can operate your Bridge from both a battery and the optional Power Supply. Connecting the Power Supply automatically disconnects the battery from the circuit.

Perform the next step only if no battery has been installed.

- () Locate the length of large sleeving, then slide it over the battery connector as shown. This prevents the connector from shorting to any components.

- () Connect the Power Supply to P1. Then connect it to the AC line.
- () Place the POWER switch to ON. LED D1 should light.
- () Touch the voltmeter to SW1 lug 2. The reading should be at least + 10.2 volts DC.
- () Place the POWER switch to OFF.

Proceed to "Adjustments."

ADJUSTMENTS

The simple design of your Antenna Noise Bridge eliminates the need for any complex alignment. The only adjustment you will make is to ensure that the knob of reactance tuning capacitor C1 is set at the correct zero point.

Refer to Pictorial 3-2 for the following steps.

- () Temporarily solder a short wire between the center pin of S2 (UNKNOWN) and solder lug B.
- () Connect a coaxial cable between socket S1 (RECEIVER) and the antenna input of your receiver.
- () Set control R1 to 0.
- () Refer to the inset drawing of Pictorial 2-2 and be sure the plates of capacitor C1 are half-meshed and the knob points to 0.
- () If your receiver does not have a signal meter, connect an AC voltmeter to the receiver speaker leads. Set the voltmeter to its lowest AC volts range.
- () Turn your receiver on. If you are using a voltmeter for the signal meter, set the receiver volume control to give a one-third to one-half scale reading on the AC voltmeter. Allow the receiver (and voltmeter) to warm up.
- () Tune the receiver to the 10 MHz or 14 MHz band.

NOTE: To hear the tone clearly in the following step, we recommend that you use the AM mode of your receiver.

- () Turn on the Antenna Noise Bridge. You should hear a tone in the receiver speaker and the receiver meter should indicate a signal strength of about 9, or near half-scale. (Re-adjust the volume control as necessary to keep the AC voltmeter reading between one-third and one-half scale.)
- () Adjust control R1 for a null on the signal meter or AC voltmeter (lowest meter reading). This should be at the 0 mark.
- () Adjust capacitor C1 for a null.
- () Repeat the previous two steps until there is no further improvement.
- () Examine the knob setting of C1. If the knob points to a position other than zero (0), carefully loosen the knob setscrew, reposition the knob to zero, and retighten the setscrew.
- () Place the Noise Bridge POWER switch to OFF.
- () Locate the 51 Ω (grn-brn-blk) resistor you set aside earlier.
- () Remove the wire between the center pin of S2 (UNKNOWN) and solder lug B. Then temporarily solder the 51 Ω resistor between these two points.
- () Turn the Bridge on and readjust R1 and C1 for a null. R1 should now read near 50; C1 should remain at 0.
- () Turn the Bridge off.
- () Disconnect the receiver.
- () Unsolder and remove the 51 Ω resistor. Tape the resistor to your manual, or to the inside of the cabinet for future use.

This completes the adjustments. Proceed to "Final Assembly."

FINAL ASSEMBLY

Refer to Pictorial 4-1 for the following steps.

- () Reposition any wires that may be pinched between the cabinet and chassis, or that may be pierced when the cabinet screws are installed.
- () Slide the cabinet over the chassis and secure it with four #6 sheet metal screws.

- () Carefully peel the backing from the blue and white label. Refer to the inset drawing and press the label onto the bottom of the chassis. Refer to the numbers on this label in any correspondence you may have with the Heath Company about your kit.

This completes the "Final Assembly" of your kit. Proceed to "Operation."

OPERATION

This section of the Manual explains how to get the most from your Antenna Noise Bridge. It begins with the "Control Functions," which describe each control and connector. "Measurements" then briefly describes all of the ways you can use this Bridge. All of its functions are then described in detail in: "Antenna Measurements," "Tuned Circuit and Component Measurements," "Transmission Line Measurements," and "Antenna Tuner Adjustments." Read all of this information carefully before you use your Bridge.

CONTROL FUNCTIONS

Refer to Pictorials 5-1 and 5-2 as you read the information below.

Resistance — Adjusting this control tells you the resistive characteristics of the unknown antenna. Adjust it for a null on the receiver signal meter.

Reactance — This control, also adjusted for a signal null, tells you the reactive component of the unknown antenna.

OFF-ON — With this switch you can connect DC voltage from the internal battery or an external power supply to the Bridge circuit.

LED — This LED (light-emitting diode) glows to tell you the Bridge is turned on.

RECEIVER — Connect the receiver, through a 50 Ω coaxial cable, to this socket.

UNKNOWN — Connect the antenna (or components) to be tested to this socket.

+9 VDC — This jack allows you to connect an external power source, such as the optional Model PS-2350, to the Bridge. The internal battery is automatically disconnected when an external power source is plugged into this jack.

GROUND — This stud allows you to connect an external ground, such as a cold water pipe or ground rod, to the Bridge. A good ground connection ensures that your measurements will represent only the antenna and feedline characteristics.

MEASUREMENTS

There are a number of ways you can use your Antenna Noise Bridge. (1.) You can measure the resistive and reactive characteristics of an antenna, find its resonant frequency, or adjust it to a specific frequency. (2.) You can use it to determine the resonant frequency of a series- or parallel-tuned LC circuit, or find the value of an unknown capacitor or inductor. (3.) You can adjust a tuned feedline, or 1/4-wave trap. (4.) And you can use your Bridge to preset an antenna tuner, saving tune-up time. The information in the following parts of the "Operation" section give you detailed instructions for each of these uses.

NOTES:

- To use your Antenna Noise Bridge, you will need a shortwave receiver or amateur radio receiver that covers the frequencies of your antennas. The receiver should receive AM or wide-band SSB signals, and have a signal meter. An AC voltmeter connected to the receiver speaker terminals can serve as a signal meter if your receiver does not have one.
- For the most accurate measurements, the unknown antenna (or load) should be connected to the UNKNOWN socket with the shortest possible length of coaxial cable. Otherwise, the characteristics of the cable can mask those of the antenna.
- When antenna measurements are being made close to the frequency of strong signals, the Bridge null may be obscured. The elements of the Bridge will react to the strong signal rather than the characteristics of the antenna.

CAUTION: If you use a transceiver with your Noise Bridge, DO NOT attempt to transmit with the Noise Bridge connected. Damage to both units may result.

ANTENNA MEASUREMENTS

Adjusting an Antenna

Refer to Pictorial 5-3 for the following steps.

1. Connect the antenna to the UNKNOWN socket.
2. Connect the receiver to the RECEIVER socket and turn it on.
3. Tune the receiver to the expected resonant frequency of the antenna and set it to receive AM or wide-band SSB signals.
4. Set the Bridge RESISTANCE (R) control to the impedance of your antenna feedline. (For most coaxial cables this will be either 50 or 75 ohms.) Then set the REACTANCE (X) control to zero (0).
5. Turn the Bridge on. You should hear a tone in the receiver speaker and see a signal meter reading near S9 (half-scale).
6. Adjust the RESISTANCE (R) control for a null on the signal meter (minimum meter reading). Then adjust the REACTANCE (X) control for a null.
7. Repeat the last step until you obtain the lowest possible meter reading.
8. Note the RESISTANCE (R) and REACTANCE (X) control readings. A perfectly tuned, or "matched" antenna should indicate an R reading of 50 to 75 ohms (representing the total antenna impedance), and an X reading of zero (0), indicating the antenna appears as a purely resistive load.

Heathkit[®]

If the R reading is significantly below the 50-ohm mark, suspect that your antenna or feedline has a shorted lead. If the R reading is significantly above the 50-ohm mark, suspect your antenna has an open or broken lead. Locate and correct either condition before you proceed.

If your antenna shows a reactance reading on the X_L side of zero (0), the antenna's resonant frequency is **below** the desired frequency. Therefore the antenna is too long and must be shortened.

If your antenna shows a reactance reading on the X_C side of zero (0), the antenna's resonant frequency is **above** the desired frequency. The antenna, therefore, is too short and must be lengthened.

To determine how much the antenna must be shortened or lengthened, retune the receiver until you get a reactance reading of zero (0), indicating the resonant frequency of the antenna. Then divide the desired frequency by the resonant frequency you just measured. This gives you the percentage of error of the antenna. You can then shorten or lengthen the antenna by that percentage.

Finding the Antenna Resonant Frequency

1. Connect the unknown antenna to the UNKNOWN socket.
2. Connect the receiver to the RECEIVER socket.
3. Tune the receiver to a frequency near the expected resonant frequency of the antenna. You can calculate this frequency from the following formula. NOTE: The formula below is considered the most accurate method for determining lengths of wire antennas for bands below 30 MHz.

$$f(\text{MHz}) = \frac{468}{\text{length (ft)}} \quad \text{Where length is the length of the antenna in feet, and } f \text{ is the frequency in MHz.}$$

4. Turn the receiver on and set it to receive AM or wide-band SSB signals.
5. Set the RESISTANCE (R) control to the impedance of your antenna feedline. This will be 50 or 75 ohms for most coaxial cables.
6. Set the REACTANCE (X) control to zero (0).
7. Turn the Bridge on. You should hear a tone in the receiver speaker and see a signal meter indication.
8. Adjust the RESISTANCE and REACTANCE controls for a null on the receiver meter (minimum reading). Repeat the adjustment until there is no further reduction in the meter reading.
9. Examine the RESISTANCE (R) and REACTANCE (X) control readings. An antenna tuned to the receiver frequency should have an R reading of 50 to 75 ohms (the total impedance of the antenna) and an X reading near zero (0), indicating the antenna appears as a purely resistive load.

If the X reading falls in the X_L range, the antenna resonant frequency is **lower** than the receiver frequency. Retune the receiver to a lower frequency; then readjust the R and X controls for a null. If the X reading falls in the X_C range, retune the receiver to a higher frequency and repeat the above adjustments. When the X control reads 0, the receiver is tuned to the antenna's resonant frequency.

Finding Non-resonant Characteristics

Use this procedure to determine the characteristic impedance of your antenna at a frequency other than resonance.

1. Connect your antenna to the UNKNOWN socket.
2. Connect your receiver to the RECEIVER socket.
3. Tune your receiver to the desired operating frequency.

4. Turn the Bridge on and adjust both controls for a null. Repeat the adjustments until no further improvement can be made.
5. Note the RESISTANCE (R) and REACTANCE (X) control settings.
6. Refer to Pictorial 5-4. Locate the REACTANCE (X) reading on the left-hand scale. Be sure to use the appropriate scale for X_C or X_L readings. Then find the corresponding reactance on the right-hand scale by placing a straightedge on the scale and reading the reactance directly across from the X_C or X_L value.

Alternately, you can calculate the value from the following formulas:

$$X_C = \frac{159155}{68 - C} - 2340 \quad X_L = 2340 - \frac{159155}{68 + C}$$

Where C is the capacitance value from the REACTANCE control.

The reactance number determined above represents the value of your antenna at 1 MHz. Find the value at the desired operating frequency by using the formula:

$$X_t = \frac{X}{f} \quad \text{Where X is the reactance from the chart and f is the desired frequency.}$$

You can now calculate the characteristic impedance of your antenna at the desired frequency from the formula:

$$Z = \sqrt{(R)^2 + (X)^2} \quad \text{Where R is the resistance reading, X is the reactance value from above, and Z is the impedance.}$$

TUNED CIRCUIT AND COMPONENT MEASUREMENTS

You can use the Antenna Noise Bridge to locate the resonant frequency of tuned circuits and to determine the value of capacitors and inductors to within $\pm 20\%$.

Refer to Pictorial 5-5 for the following steps.

Series-tuned Circuits

1. Connect the series-tuned circuit across the UNKNOWN socket.
2. Set the RESISTANCE (R) control at a low value. (A series-tuned circuit at resonance represents a very low impedance.)
3. Set the REACTANCE (X) control to zero (0).
4. Tune the receiver for a null indication. (The null may be very broad.) The frequency at which the null occurs is the resonant frequency of the circuit.

Parallel-tuned Circuits

Refer to the inset drawing on Pictorial 5-5 for the following steps.

1. Make a two-turn coupling link from a short length of wire and connect this link to the UNKNOWN socket.
2. Place the coupling link close to the inductor of the parallel-tuned circuit. NOTE: If the inductor uses a toroid core, the two-turn link must be wound **through** the core.
3. Set the RESISTANCE (R) control to a low value and the REACTANCE (X) control to zero (0).
4. Tune the receiver for a null indication, which may be broad. The null frequency is the resonant frequency of the circuit.

Inductors

1. Connect a 100 pF mica capacitor (CTEST) in series with the unknown coil. Then connect this series circuit to the UNKNOWN socket.
2. Set the RESISTANCE and REACTANCE controls to zero (0).
3. Tune the receiver for a null, as you would for a series-tuned circuit. Use the resonant frequency in the following formula:

$$L = \frac{253.3}{(f)^2} \quad \text{Where } f \text{ is the frequency in MHz.}$$

Capacitors

1. Connect a 4.7 μ H (yel-viol-gld-sil) coil (LTEST) across the UNKNOWN socket.
2. Set the RESISTANCE (R) control to zero (0).
3. Tune the receiver to 2 MHz and adjust the REACTANCE (X) control for a null.
4. Connect the 4.7 μ H coil (LTEST) in series with the unknown capacitor and connect this circuit to the UNKNOWN socket.
5. **Without readjusting** either control, tune the receiver for a null. Then use the null frequency in the following formula:

$$C = \frac{5389}{(f)^2} \quad \text{Where } f \text{ is the frequency in MHz.}$$

TRANSMISSION LINE ADJUSTMENTS

You can use the Noise Bridge to find the resonant frequency of, or adjust the length of, a one-quarter wavelength transmission line.

Finding the Resonant Frequency

1. Short out the UNKNOWN socket. Then adjust the RESISTANCE and REACTANCE controls for a null. Both controls should be near zero.

2. Remove the short and connect the transmission line length to the UNKNOWN socket. The other end of the line should be open.
3. Tune the receiver for the best null. This will be the exact frequency the line is tuned to.

Tuning a Transmission Line Length to a Frequency

First calculate the length of transmission line you need for a 1/4 wavelength from the following formula:

$$l = \frac{246}{f} \times V \quad \text{Where } V \text{ is the velocity factor of the transmission line used and } f \text{ is the desired frequency in MHz. You can find velocity factor in the ARRI, Antenna Handbook or Radio Amateur's Handbook.}$$

Cut the length of transmission line slightly longer than the calculated length. Then proceed as follows:

1. Connect a short across the UNKNOWN socket and adjust the Bridge for the best null at the desired frequency. Both controls should be near zero (0) for the best null.
2. Remove the short. Then connect the length of line to the UNKNOWN socket. Be sure the receiver is tuned for the desired frequency and shorten the length of the line in small steps until the null is very close to the reading from the step above. You may want to check the resonant frequency of the line after each trimming to see how close it is to the desired frequency.

For a 1/2 wavelength line, double the calculated length above. Then use the same procedure as before, but **short** the end of the transmission line.

ANTENNA TUNER ADJUSTMENTS

You can use this procedure to preset your antenna tuner for the desired operating frequency. This will prevent interference to other stations and reduce the amount of tuning required.

Refer to Pictorial 5-6 for the following steps.

1. Connect the antenna tuner to the UNKNOWN socket and the receiver or transceiver to the *RECEIVER* socket.
2. Set the *RESISTANCE* control to 50 and the *REACTANCE* control to zero (0).
3. Set the antenna tuner to the proper band, if appropriate, or preset the tuner inductor as directed in the tuner manual. The tuner capacitors should be preset to the center of their rotation.

4. Tune the receiver to the desired operating frequency. Then adjust the antenna tuner controls for a null on the receiver meter, or a null in the noise level from the speaker.

This places the tuner very close to the desired frequency. A small readjustment of the tuner may be necessary to peak the transmitter output.

IN CASE OF DIFFICULTY

This part of the Manual will help you locate and correct difficulties that may occur in your Antenna Noise Bridge. The "Visual Checks" give you suggestions of a general nature that are especially useful for any problems that occur right after your unit is assembled.

If the "Visual Checks" fail to clear up the problems, or if difficulties occur after your unit has been in use for some time, refer to the "Troubleshooting Chart."

NOTE: Refer to the "Circuit Board X-Ray View" for the physical location of parts.

VISUAL CHECKS

1. Recheck the wiring. Trace each lead with a colored pencil on the Pictorial as you check it. It is frequently helpful to have a friend check your work. Someone who is not familiar with the unit may notice something you consistently overlooked.
2. About 90% of the kits that are returned to the Heath Company for service do not function properly due to poor connections and soldering. Therefore, you can eliminate many troubles by reheating all connections to make sure they are soldered as described in the "Soldering" instructions on Pages 11 and 12.
3. Closely examine the circuit board foil in a good light to see that no solder bridges exist between adjacent connections. Remove any solder bridges by holding a clean, hot soldering iron tip between the two points that are bridged until the excess solder flows down onto the tip.

Compare your foil patterns with the "Circuit Board X-Ray View."

4. Check to be sure each transistor lead is connected to the proper point.
5. Check to be sure the correct diode is installed at each diode location. Make sure each diode band is positioned above the diode band printed on the circuit board.
6. Check each capacitor value. Make sure that a capacitor of the correct value is installed at each capacitor location.
7. Check each resistor value carefully. Be sure in each step that the proper part has been wired into the circuit as shown in the Pictorial diagrams.
8. Be sure all the wires and leads connected to the circuit board have been trimmed as close as possible to the circuit board foils.
9. Check for bits of solder, wire ends, or other foreign matter which may be lodged in the wiring.
10. Be sure each lead of the IC is inserted into the socket and not bent underneath.

If you still have not located the trouble after the "Visual Checks" are completed, and if a voltmeter is available, check the voltage readings at the locations indicated on the Schematic diagram. NOTE: All voltage readings were taken with a high-input impedance voltmeter. Voltages may vary slightly, up to $\pm 10\%$.

NOTE: In an extreme case where you are unable to resolve a difficulty, refer to the "Customer Service" information inside the rear cover of this Manual. Your Warranty is located inside the front cover.

TROUBLESHOOTING CHART

This chart lists the “Condition” and “Possible Cause” of several malfunctions. If a particular part or parts are mentioned (D1 for example) as a possible cause, check that part, and any associated parts, to

see if it was installed and/or wired correctly. It is also possible, on rare occasions, for a part to be faulty and require replacement.

CONDITION	POSSIBLE CAUSE
D1 does not light.	<ol style="list-style-type: none"> 1. Battery is dead 2. SW1 miswired. 3. P1 miswired. 4. D1 installed backwards.
No noise output.	<ol style="list-style-type: none"> 1. D101, D102, D103 installed backwards, or wrong type used. 2. U101 installed backwards. 3. Q101, Q102 installed incorrectly or shorted. 4. T101 wound incorrectly. 5. Bridge not properly connected to receiver.
Noise signal is present, but Bridge will not null.	<ol style="list-style-type: none"> 1. T101 wound incorrectly. 2. S1, S2 reversed. 3. R1, C1 miswired or shorted.
Low noise output.	<ol style="list-style-type: none"> 1. Battery is weak. 2. Q101, Q102 weak. 3. U101 weak. 4. D103 installed backwards.
Noise signal is present, but has no modulating tone.	<ol style="list-style-type: none"> 1. U101 shorted. 2. D101, D102 installed backwards or shorted. 3. Receiver is in SSB mode. Use AM mode.

SPECIFICATIONS

Front Panel Range	Resistance: 0 to 200 Ω . Capacitance: ± 60 pF.
Operating Range	1 to 30 MHz.
Useful Range	1 to 100 MHz.
Power Requirements	Internal 9-volt battery (#NEDA 1604), or external 9-11 VDC @ 45 mA.
Accessory (Optional)	Model PS-2350 Power Supply.
Input Connectors	SO239 coaxial sockets.
Net Weight	18 oz. (.5 kg).
Overall Dimensions	2-1/4"H \times 5-1/8"W \times 5"D (5.7 \times 13 \times 12.7 cm).

The Heath Company reserves the right to discontinue products and to change specifications at any time without incurring any obligation to incorporate new features in products previously sold.

CIRCUIT DESCRIPTION

Refer to the Schematic and Pictorial 6-1 as you read the "Circuit Description" section. The components are arranged in the following groups to help you locate specific parts on the schematic and circuit board.

- 1-99 Parts mounted on the chassis.
- 100-199 Parts mounted on the circuit board.

The Antenna Noise Bridge consists of two circuits. The first generates a tone-modulated noise signal, while the second comprises an impedance bridge circuit.

U101 is a 555 timer IC used as an audio oscillator. R102, R103, and C103 determine the oscillation frequency of 1 kHz. D102 and D103 provide feedback for the input and a discharge path for the capacitor. The output signal is coupled by R106 to D103.

A broadband (white) noise signal is generated by the current flow through zener diode D103. This noise signal is modulated by the 1 kHz signal from oscillator U101 and coupled to amplifiers Q101 and Q102. The transistors amplify the noise signal to a level (about 50 μ V) that produces an S9 signal in most receivers.

Pictorial 6-1 illustrates the bridge portion of the circuit, which consists of T101, C107, R1, C1, and the impedances of the unknown antenna (or component) and the receiver. T101 is a trifilar transformer with three equal, in-phase windings. One of its windings, leads 1 and 4, is used to couple the modulated noise signal to the bridge circuit. The remaining windings are arranged so each is in one leg of a bridge. A second winding (leads 2 and 5) combines with C107 and the unknown antenna to form one leg, while the third winding (leads 3 and 6) combines with R1 and C1 to form the remaining parallel leg of the bridge circuit. The receiver connects across the two legs of the bridge.

When you adjust R1 and C1 to equal the impedance of the unknown antenna, making both legs of the bridge equal, the noise signal appearing at point E will be at a minimum. This is because impedances (or resistances) in parallel are at their lowest total value when the two values are equal. If either leg of the bridge is not equal to the other, the signal at point E will increase because the total value of the impedance increases, causing a higher signal level to appear at the receiver connector. By adjusting R1 and C1 to a null on the receiver signal meter, you match their resultant impedance to that of the unknown antenna. You can then read the resistance and reactance components of the unknown antenna directly from each control.

SEMICONDUCTOR IDENTIFICATION

<u>COMPONENT NUMBER</u>	<u>HEATH PART NUMBER</u>	<u>MAY BE REPLACED WITH</u>	<u>KEY NUMBER</u>
-------------------------	--------------------------	-----------------------------	-------------------

DIODES

D103	56-6	VR6.8	A1
D101-D102	56-56	1N4149	A1

A1

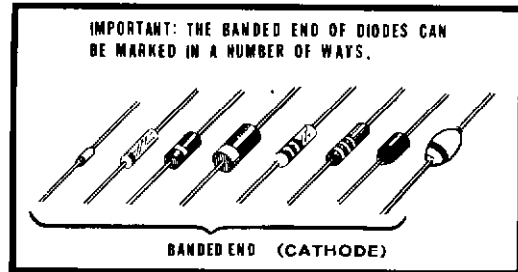

LED

D1	412-633	Red LED 1.6 V, 20 mA	B1
----	---------	-------------------------	----

TRANSISTORS

Q101, Q102	417-293	2N5770	C1
------------	---------	--------	----

INTEGRATED CIRCUIT

U101	442-53	555	D1
------	--------	-----	----

B1

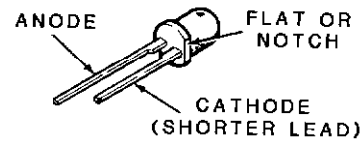

C1

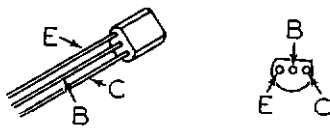

B1

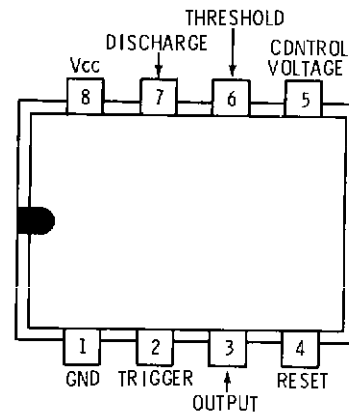

CIRCUIT BOARD X-RAY VIEW

NOTE: To find the PART NUMBER of a component for the purpose of ordering a replacement part:

- A. Find the circuit component number (R5, C3, etc.) on the X-Ray View.
- B. Locate this same number in the "Circuit Component Number" column of the "Parts List" in the front of this Manual.
- C. Adjacent to the circuit component number, you will find the PART NUMBER and DESCRIPTION which must be supplied when you order a replacement part.

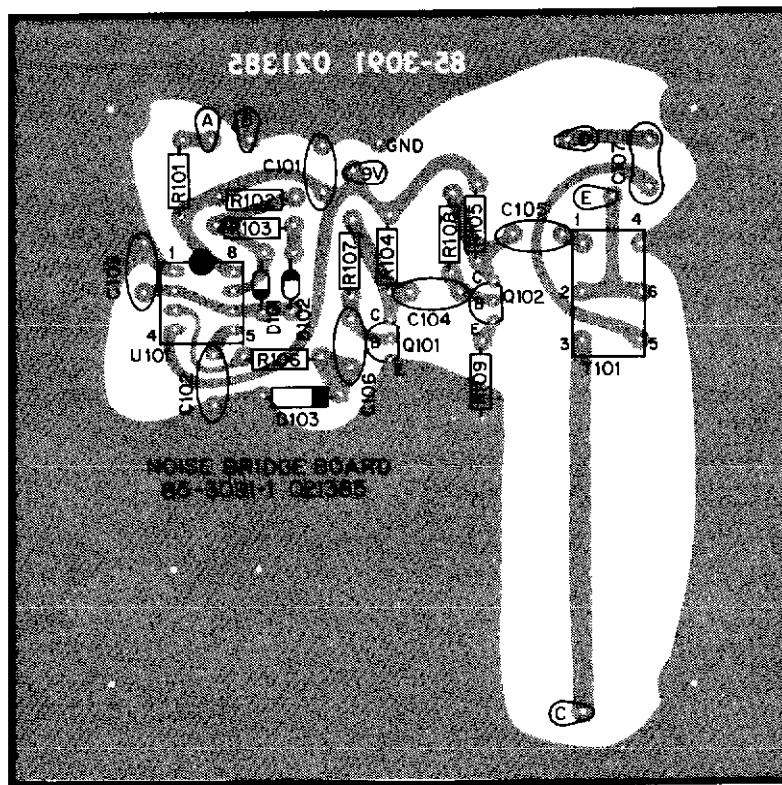

(Shown from the component side)

TAPED COMPONENT CHART

Read and Follow These Instructions Before You Install The First Component

Use masking tape, as shown in the Taping Detail, to tape the component strips over the component drawings. Be sure each part on the strip is over its correct illustration; and that resistor color bands, and any part numbers, match their drawings. Cut the tape, as necessary, to align each section. Do not remove any parts from the strip until they are called for in the assembly instructions.

NOTE: Never attempt to pull the components free from the tape; gum residue from the tape could cause an intermittent connection. Use diagonal cutters to remove each part as it is called for in the assembly instructions. Cut the leads at the inside edge of the tape as shown.

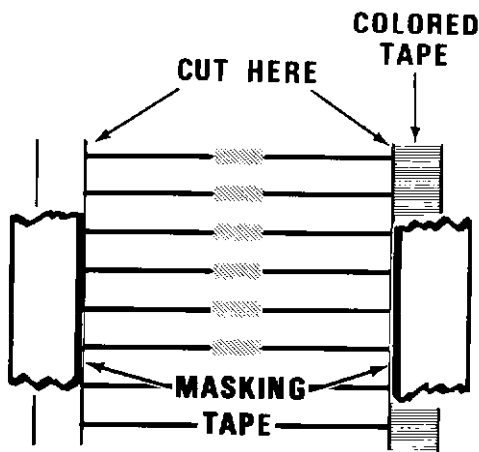

Taping Detail

SECTION 1

- 390 Ω (org-wht-brn) _____
- 6800 Ω (blu-gry-red) _____
- 6800 Ω (blu-gry-red) _____
- 22 k Ω (red-red-org) _____
- 1N4149 (#56-56) _____
- 1N4149 (#56-56) _____
- 1800 Ω (brn-gry-red) _____
- VR6.8 (#56-6) _____

SECTION 2

- 1200 Ω (brn-red-red) _____
- 10 k Ω (brn-blk-org) _____
- 680 Ω (blu-gry-brn) _____
- 470 Ω (yel-vio-brn) _____
- 51 Ω (grn-brn-blk) _____

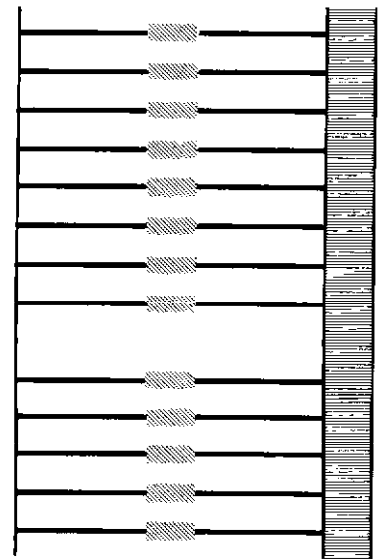

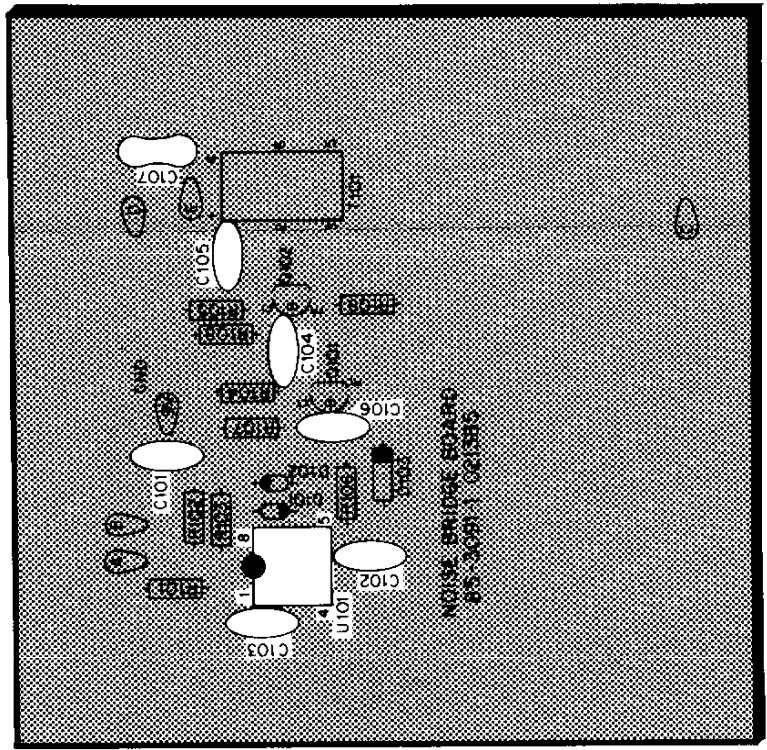
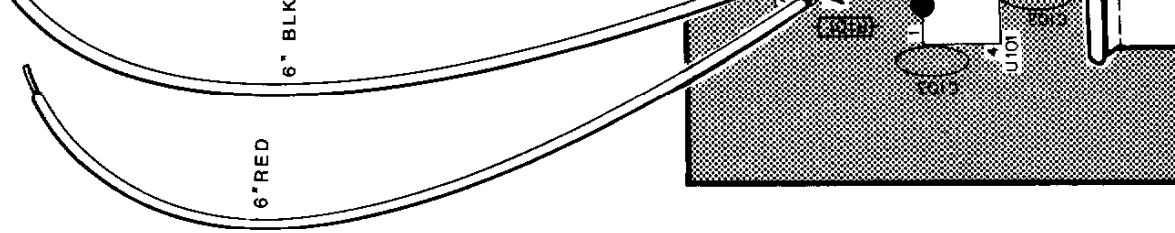

PICTORIAL 1-2

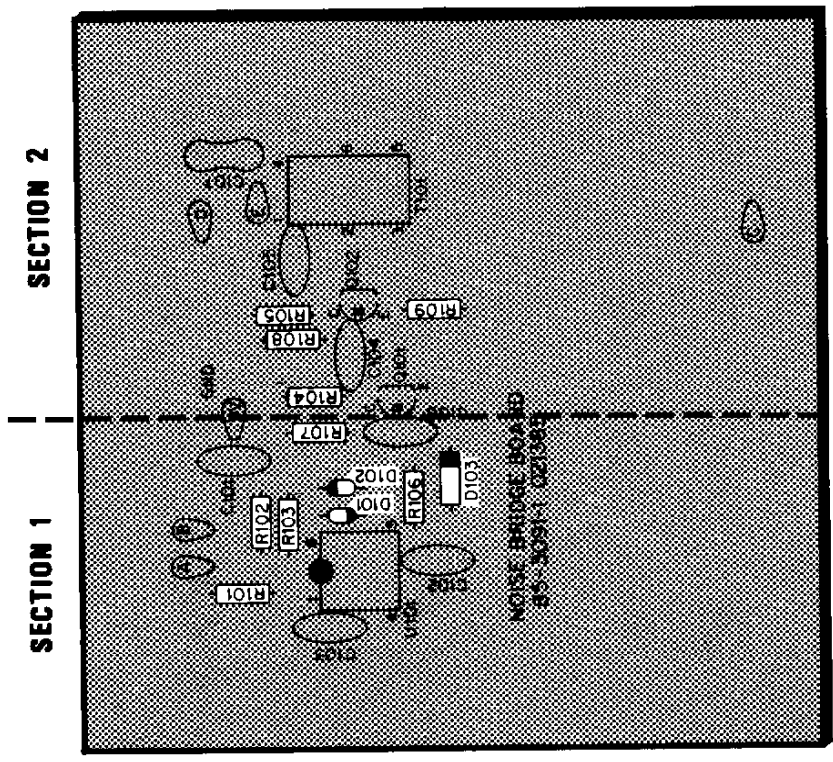

PICTORIAL 1-1

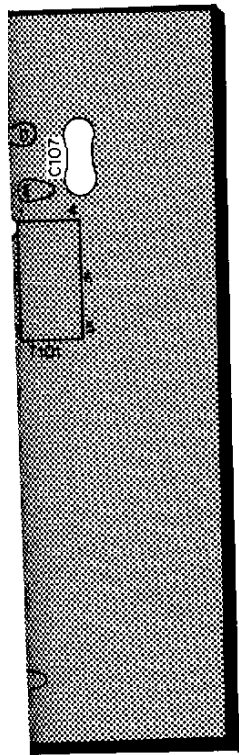

-2

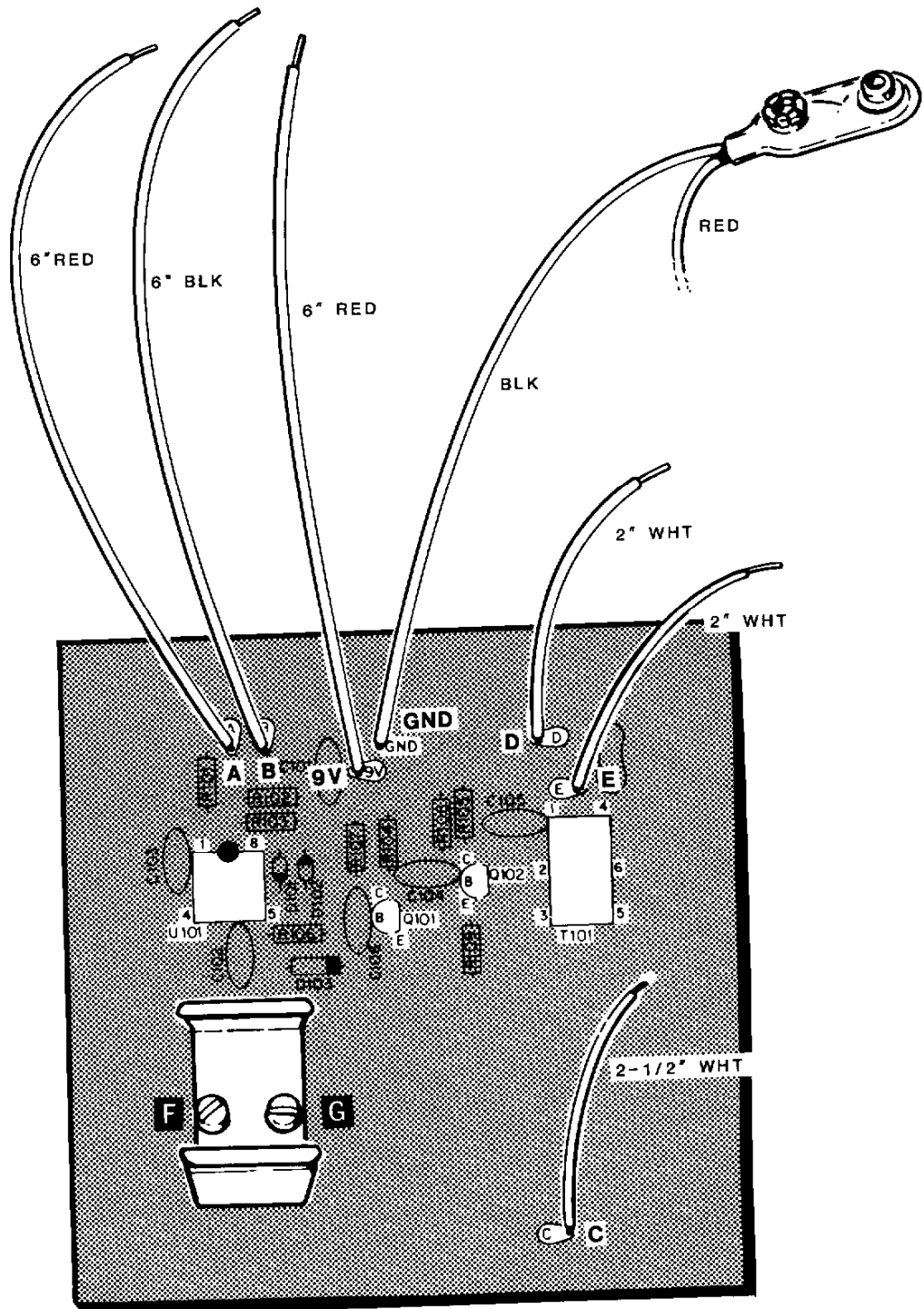

PICTORIAL 1-3

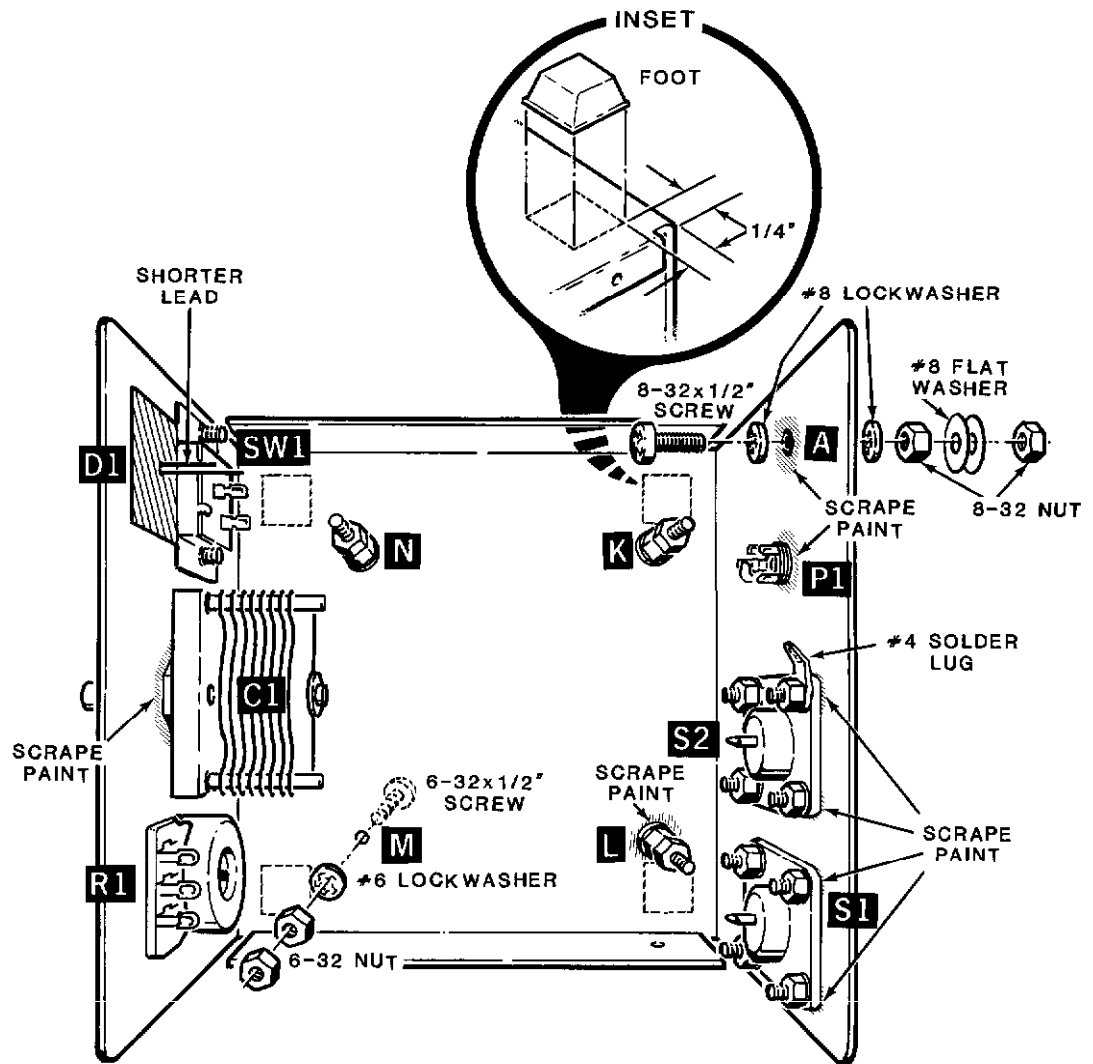

PICTORIAL 2-1

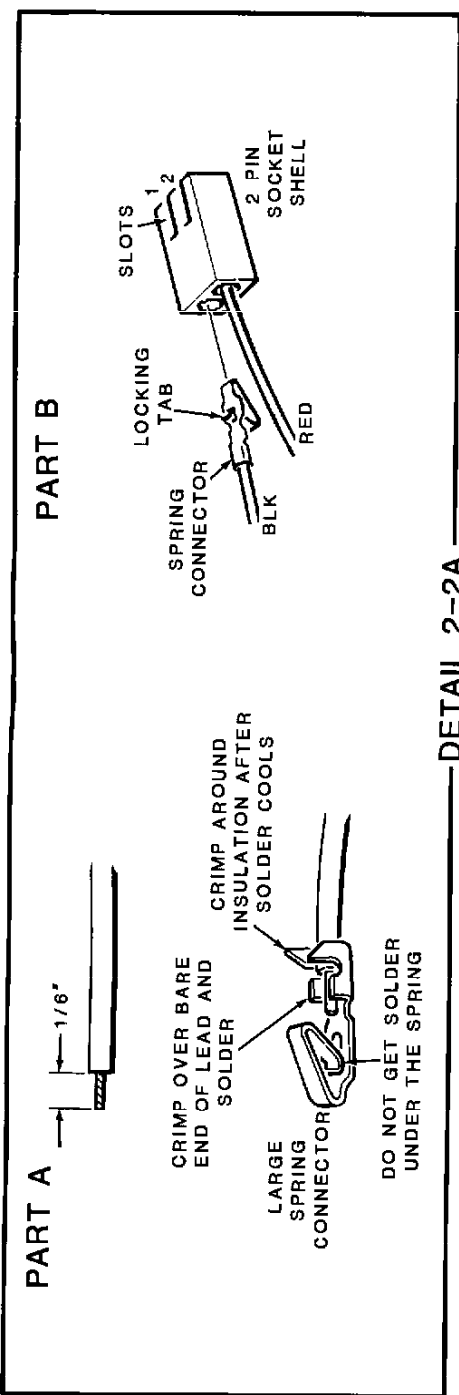

DETAIL 2-2A

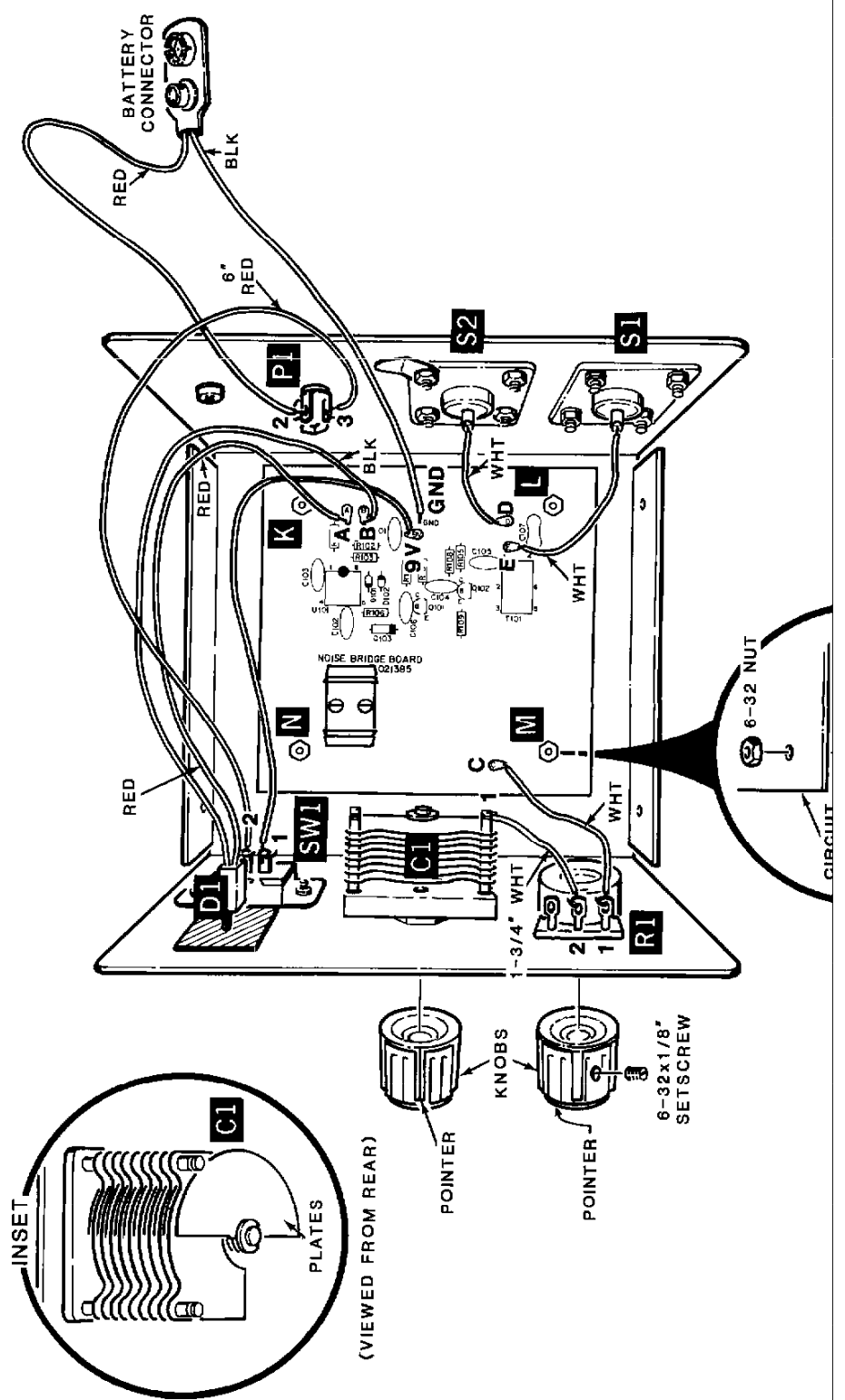

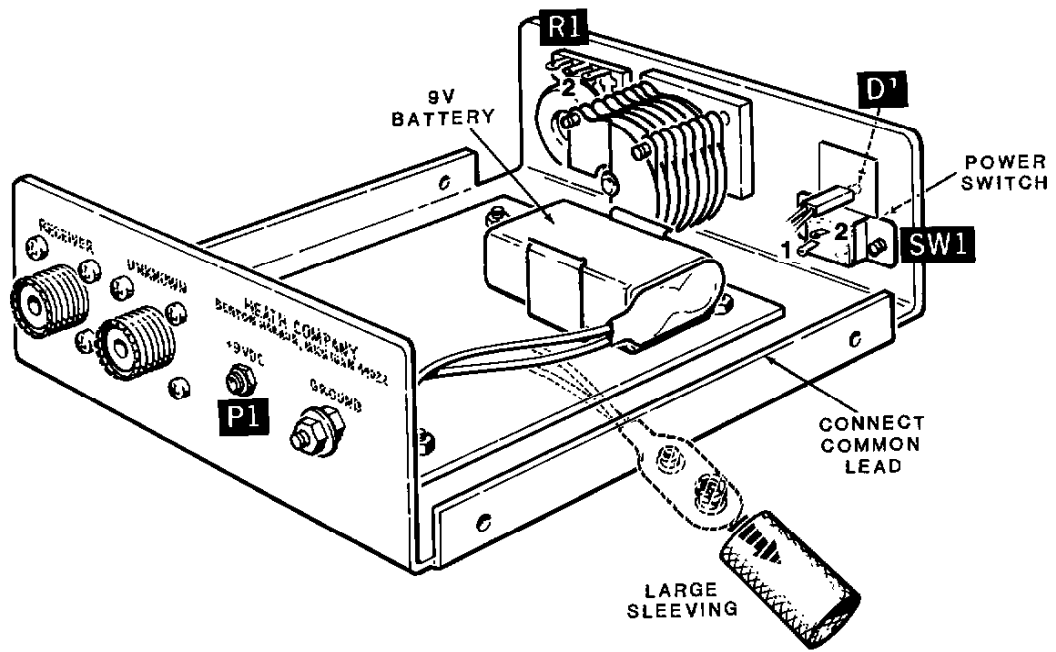

PICTORIAL 3-1

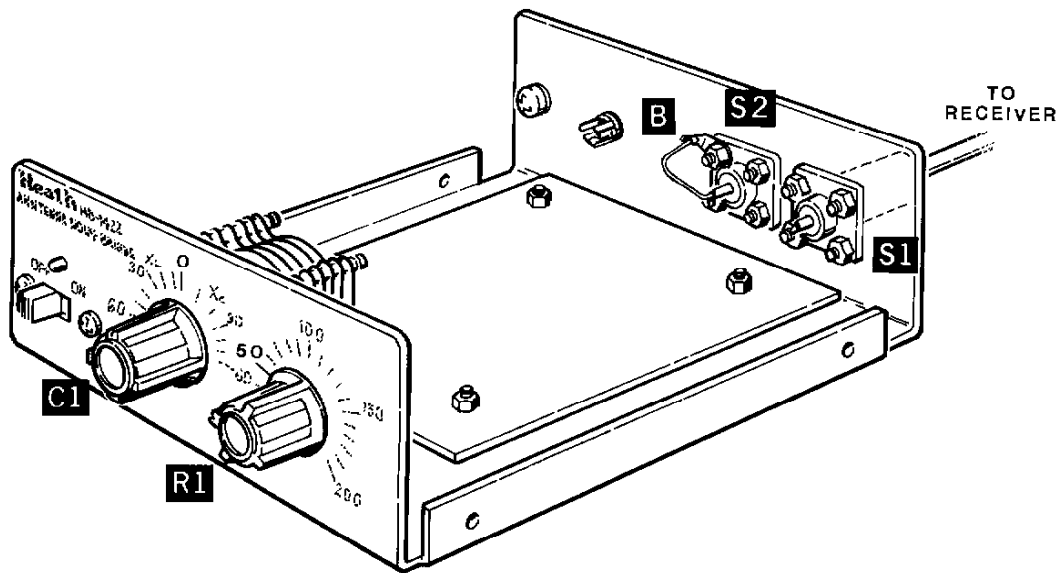

PICTORIAL 3-2

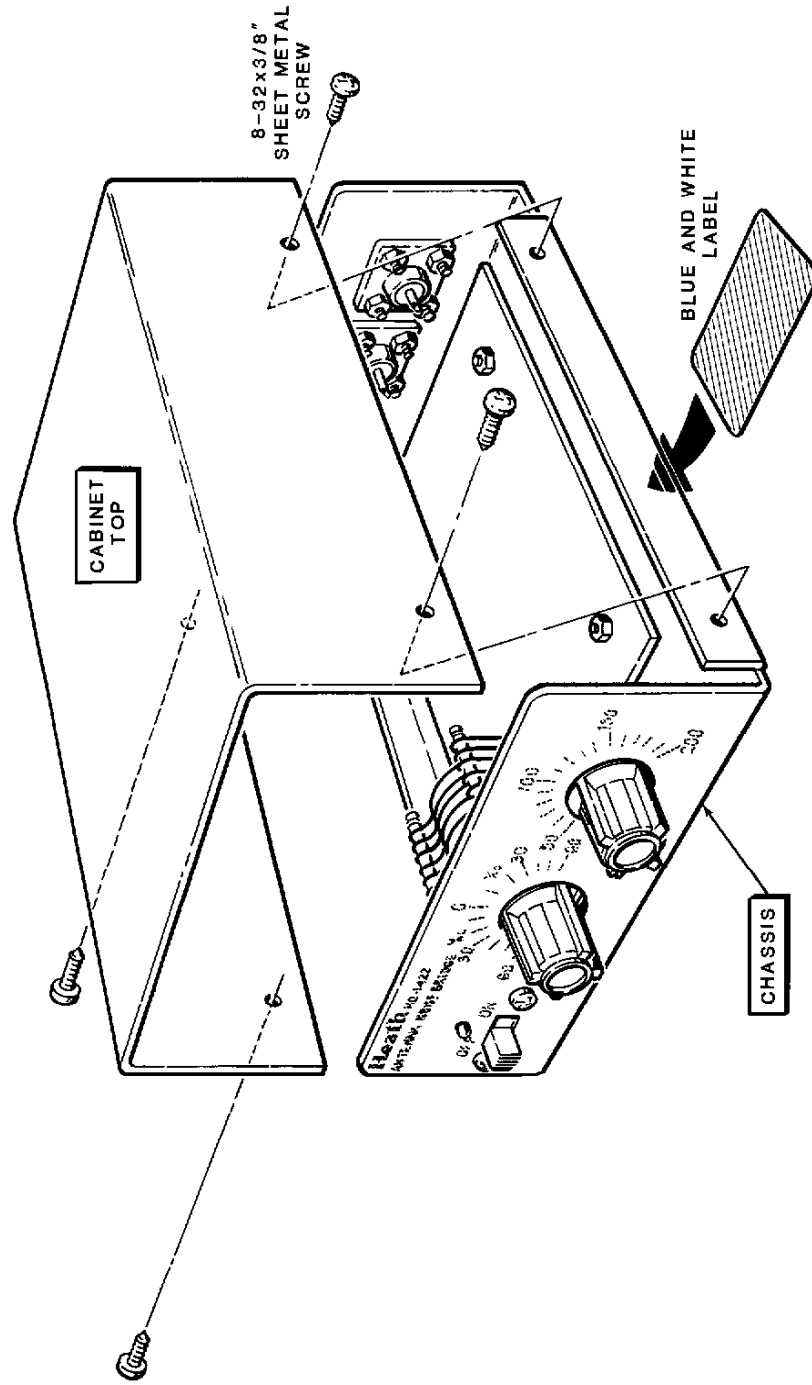

PICTORIAL 4-1

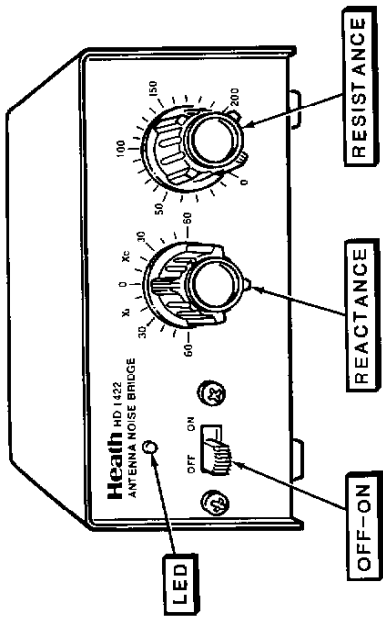

PICTORIAL 5-1

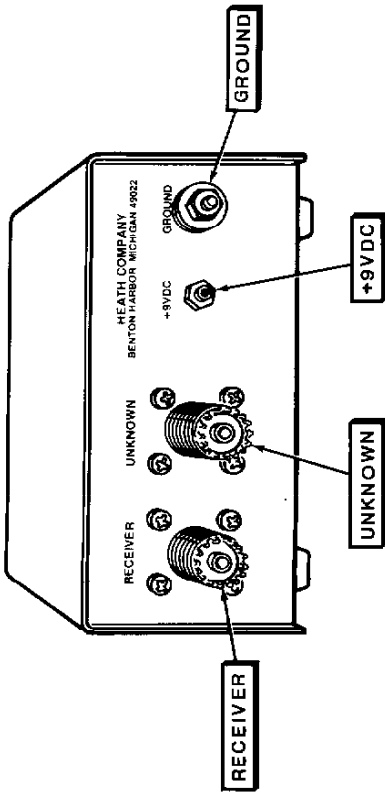

PICTORIAL 5-2

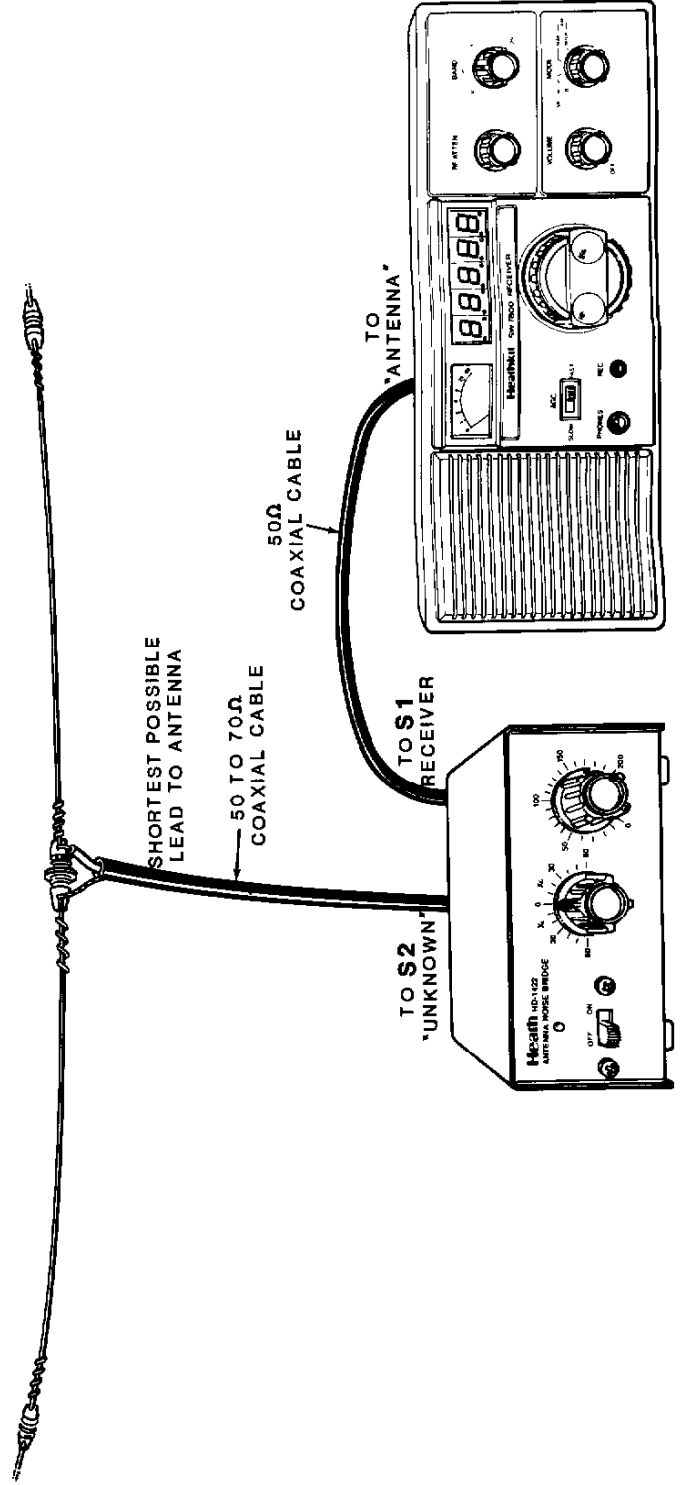

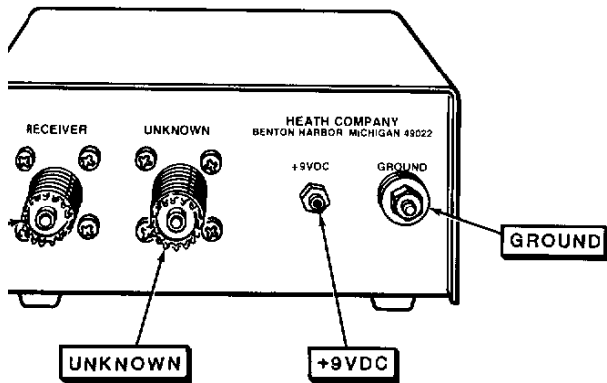

PICTORIAL 5-2

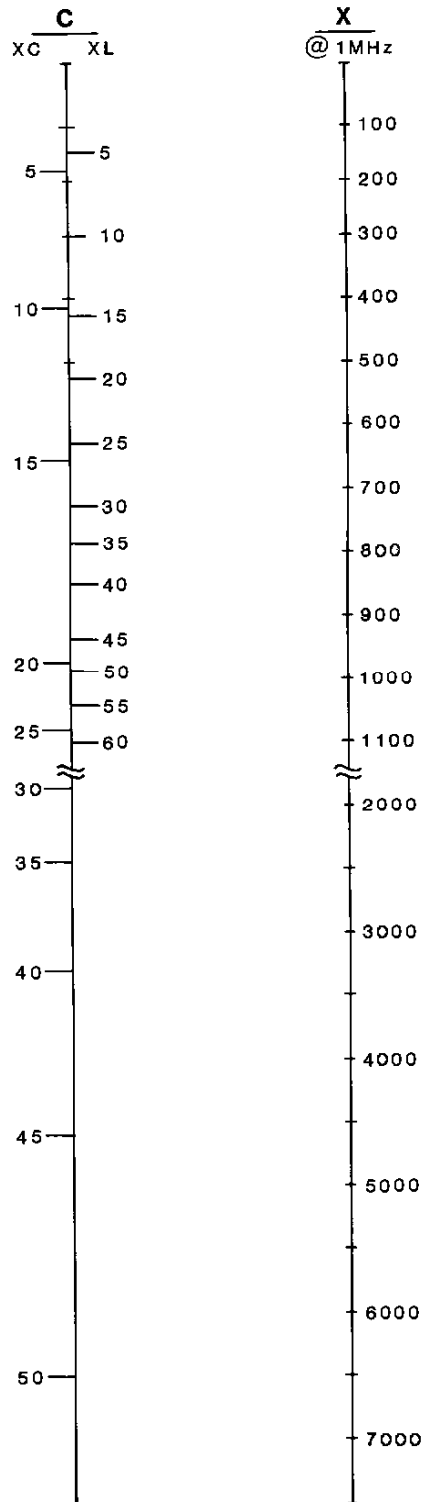
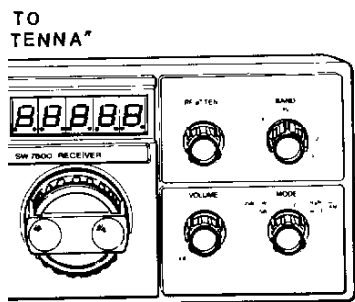

PICTORIAL 5-4

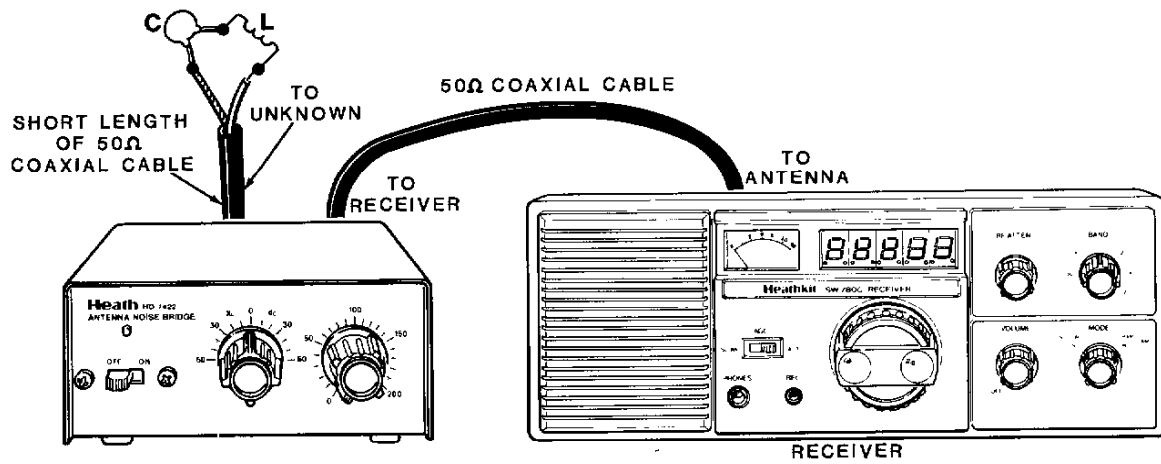
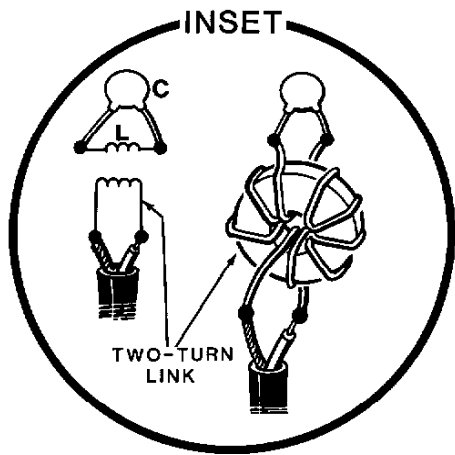

PICTORIAL 5-5

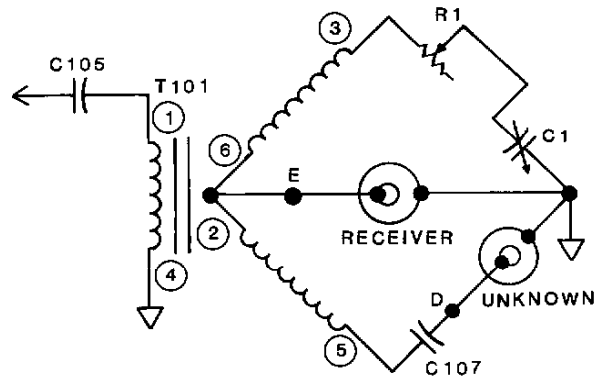

PICTORIAL 6-1

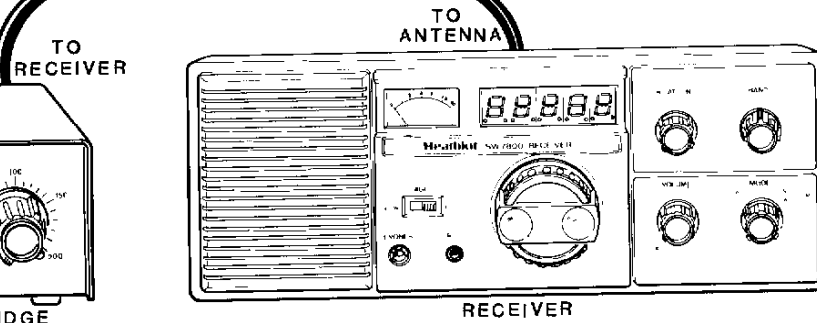
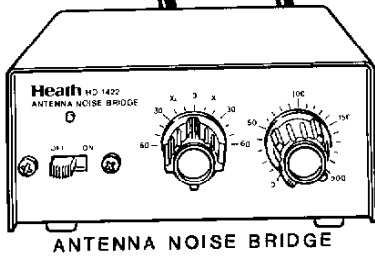
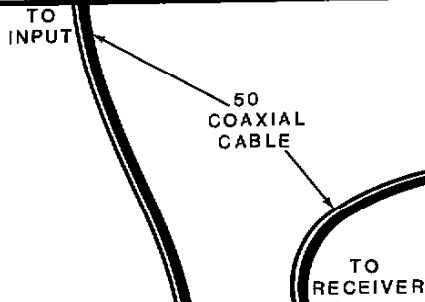
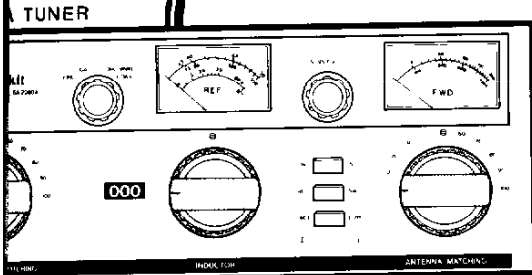
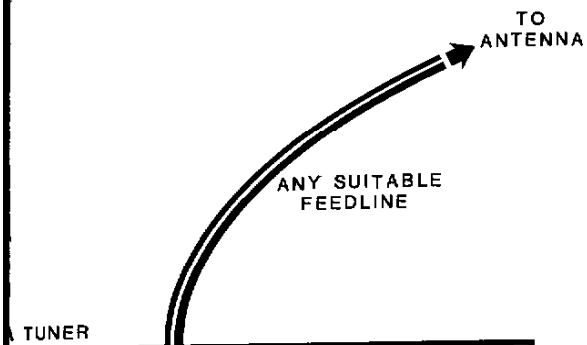

PICTORIAL 5-6

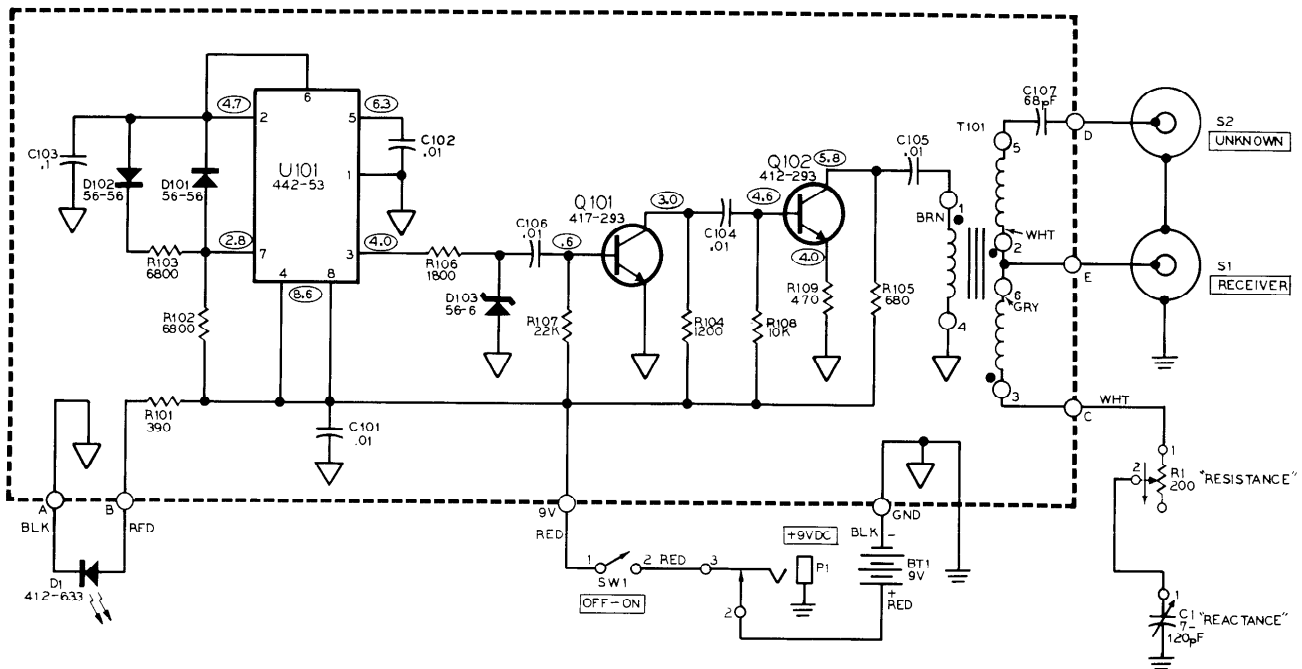

**SCHEMATIC FOR THE
HEATHKIT®
ANTENNA NOISE BRIDGE
MODEL HD-1422**

SCHEMATIC NOTES:

1. COMPONENT NUMBERS ARE IN THE FOLLOWING GROUPS:
1 - 100 PARTS MOUNTED ON THE CHASSIS.
100 - 199 PARTS MOUNTED ON THE CIRCUIT BOARD.
2. ALL RESISTORS ARE 1/4 WATT, 5%. RESISTOR VALUES ARE IN OHMS (K - 1,000).

3. CAPACITOR VALUES ARE IN μF UNLESS OTHERWISE SPECIFIED.
4. ○ THIS SYMBOL INDICATES A POSITIVE DC VOLTAGE FROM THE POINT INDICATED TO CHASSIS GROUND, MEASURED WITH A HIGH IMPEDANCE VOLTMETER.
5. ▽ THIS SYMBOL INDICATES CIRCUIT BOARD GROUND.
6. ≡ THIS SYMBOL INDICATES CHASSIS GROUND.
7. (A) THIS SYMBOL INDICATES A LETTERED OR NUMBERED, SOLDERED CONNECTION TO THE CIRCUIT BOARD.
8. ● THIS SYMBOL INDICATES THE SAME POLARITY FOR EACH WINDING OF TRANSFORMER T101.
9. VOLTAGES MAY VARY, DEPENDING ON POWER SOURCE.